

# CCA-E

- Zone 1, 2, 21, 22
- Group IIC
- Aluminium junction boxes
- Choice of 5 sizes
- IP66

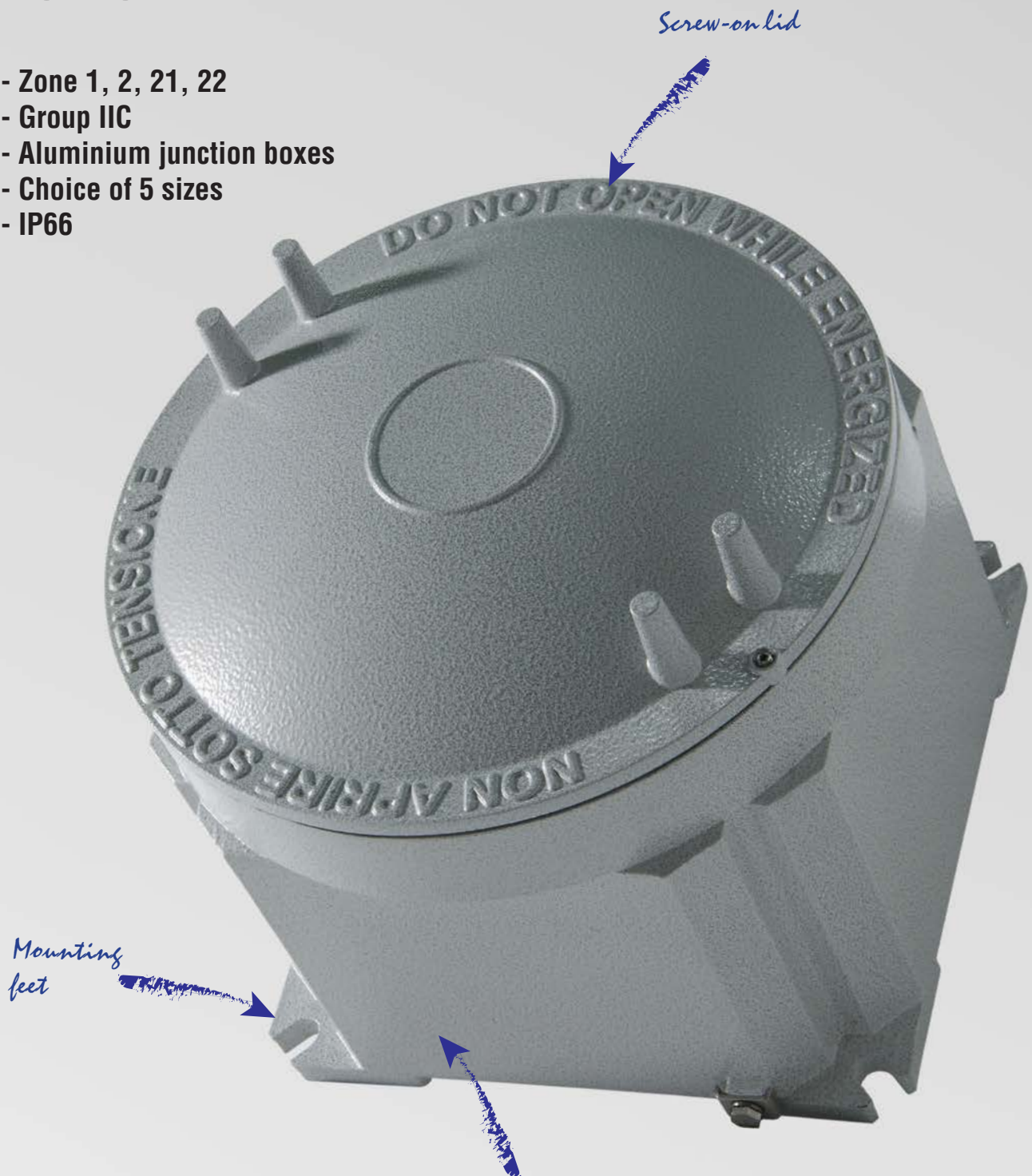

External earth screw  
in body



Polyester  
coating

Safety grub screw  
for lid

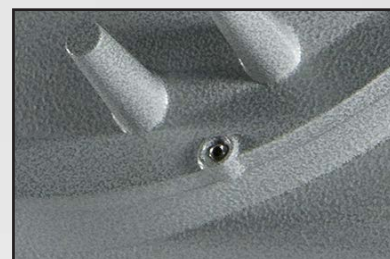

# CCA...E series Aluminium junction boxes gas group IIC

The CCA...E series junction boxes are recommended for fitting with terminals given that they provide more room, making it easier for operators to gain access. On the other hand, the smaller wall area means drilling options are limited. They are suitable for installation in any plants where there is a risk of explosion and/or fire, or areas where combustible dust is present, classified as Zone 1, 2, 21, 22. The quality of this product is recognized and valued the world over for its specific aluminium alloy and the mechanical properties of its finishes. The CCA...E series is employed where group IIC gases are present and is mostly used as a box to carry terminals, fuse carriers, transformers, reactors and barriers, though it is also used to produce control and signalling boards, light and power boards and motor starter boxes with different configurations, which are specially custom made to the requirements of our customers worldwide. The CCA...EH series features a threaded lid with a tempered glass viewing window.

Cortem Group labels its products with a non-removable adhesive label featuring a hologram and an alphanumeric univocal code, as a safety measure against the illegal sale of fakes so that all the products are guaranteed as original. Non-compliance with the International standards entails serious risks for the environment, especially for those working daily on the plants.



## Application sectors:









## CERTIFICATION DATA FOR EMPTY ENCLOSURES







<b>Classification:</b>	Group II	Category 2GD		
<b>Installation:</b> EN 60079.14	zone 1 - zone 2 (Gas)	zone 21 - zone 22 (Dust)		
<b>Marking:</b>	CE 0722 Ex II 2 GD - Ex db IIC Gb - Ex tb IIIC Db - IP66			
<b>Certification:</b>	ATEX	CESI 01 ATEX 034U		
	IEC Ex	CES 14.0012U	All IEC Ex certification data can be downloaded from <a href="http://www.cortemgroup.com">www.cortemgroup.com</a>	
	TR CU	AVAILABLE	All TR CU certification data can be downloaded from <a href="http://www.cortemgroup.com">www.cortemgroup.com</a>	
<b>Standards:</b>	CENELEC EN 60079-0: 2013, EN 60079-1: 2014, EN 60079-31: 2014, EN 60529: 1991 and EUROPEAN DIRECTIVE 2014/34/UE			
<b>Ambient Temp.:</b>	-20°C +60°C		Standard temperature on all CCAE boxes.	
	-60°C +150°C		Special temperature.	
<b>Degree of protection:</b>	IP66			

# CCA-...E series Aluminium junction boxes gas group IIC

## CERTIFICATION DATA FOR ENCLOSURES WITH TERMINALS







<b>Classification:</b>	Group II	Category 2GD		
<b>Installation:</b> EN 60079.14	zone 1 - zone 2 (Gas)	zone 21 - zone 22 (Dust)		
<b>Marking:</b>	CE 0722  II 2 GD - Ex d IIC T6, T5 Gb - Ex tb IIIC T85, T100°C Db - IP66			
<b>Certification:</b>	ATEX	CESI 01 ATEX 035		
	IEC Ex	CES 16.0013X	All IEC Ex certification data can be downloaded from <a href="http://www.cortemgroup.com">www.cortemgroup.com</a>	
	TR CU	AVAILABLE	All TR CU certification data can be downloaded from <a href="http://www.cortemgroup.com">www.cortemgroup.com</a>	
	CCoE	AVAILABLE	All CCoE certification data can be downloaded from <a href="http://www.cortemgroup.com">www.cortemgroup.com</a>	
<b>Standards:</b>	CENELEC EN 60079-0: 2009, EN 60079-1: 2007, EN 60439-1, EN 60079-31: 2009, EN 60529: 1991 and EUROPEAN DIRECTIVE 2014/34/UE			
 <b>Ambient Temp.:</b>	 -50°C +40°C 	With temperature class T6 and maximum surface temperature T85°C.		
	 -50°C +55°C 	With temperature class T5 and maximum surface temperature T100°C.		
<b>Degree of protection:</b>	IP66			

## CERTIFICATION DATA OF ENCLOSURES FOR CONTROL, MONITORING AND SIGNALLING UNITS







<b>Classification:</b>	Group II	Category 2GD		
<b>Installation:</b> EN 60079.14	zone 1 - zone 2 (Gas)	zone 21 - zone 22 (Dust)		
<b>Marking:</b>	CE 0722  II2GD - Ex db IIC T6, T5 Gb - Ex tb IIIC T85°C, T100°C Db - IP66			
<b>Certification:</b>	ATEX	CESI 01 ATEX 036X		
	IEC Ex	CES 16.0013X	All IEC Ex certification data can be downloaded from <a href="http://www.cortemgroup.com">www.cortemgroup.com</a>	
	TR CU	AVAILABLE	All TR CU certification data can be downloaded from <a href="http://www.cortemgroup.com">www.cortemgroup.com</a>	
	INMETRO	DNV 14.0152	All INMETRO certification data can be downloaded from <a href="http://www.cortemgroup.com">www.cortemgroup.com</a>	
<b>Standards:</b>	CENELEC EN 60079-0: 2012 + A11: 2013, EN 60079-1: 2014, EN 60079-31: 2014, EN 60529: 1991 and EUROPEAN DIRECTIVE 2014/34/UE			
 <b>Ambient Temp.:</b>	 -20°C +40°C 	With temperature class T6 and maximum surface temperature T85°C.		
	 -20°C +55°C 	With temperature class T5 and maximum surface temperature T100°C.		
	 -60°C	On request.		
<b>Degree of protection:</b>	IP66			

# CCA-...E series Aluminium junction boxes gas group IIC

## CERTIFICATION DATA FOR ENCLOSURES SERVING SURGE ARRESTER FUNCTION

<b>Classification:</b>	Group II	Category 2GD		
<b>Installation:</b> EN 60079.14	zone 1 - zone 2 (Gas)	zone 21 - zone 22 (Dust)		
<b>Marking:</b>	CE 0722  II2GD - Ex db IIC T6, T5 Gb - Ex tb IIIC T85°C, T100°C Db - IP66			
<b>Certification:</b>	ATEX	CESI 01 ATEX 036X		
	IEC Ex	CES 16.0013X	All IEC Ex certification data can be downloaded from <a href="http://www.cortemgroup.com">www.cortemgroup.com</a>	
	TR CU	AVAILABLE	All TR CU certification data can be downloaded from <a href="http://www.cortemgroup.com">www.cortemgroup.com</a>	
<b>Standards:</b>	CENELEC EN 60079-0: 2012 + A11: 2013, EN 60079-1: 2014, EN 60079-31: 2014, EN 60529: 1991 and EUROPEAN DIRECTIVE 2014/34/UE			
 <b>Ambient Temp.:</b>	 -20°C	 +40°C	With temperature class T6 and maximum surface temperature T85°C.	
	 -20°C	 +55°C	With temperature class T5 and maximum surface temperature T100°C.	
	 -60°C		On request.	
<b>Degree of protection:</b>	IP66			

## CERTIFICATION DATA OF ENCLOSURES SERVING INTERFACE UNIT CONTROL AND MONITORING FUNCTION

<b>Classification:</b>	Group II	Category 2GD		
<b>Installation:</b> EN 60079.14	zone 1 - zone 2 (Gas)	zone 21 - zone 22 (Dust)		
<b>Marking:</b>	CE 0722  II2(1)GD - Ex d [ia Ga] IIC T... Gb - Ex tb [ia Da] IIIC T...°C Db - IP66			
<b>Certification:</b>	ATEX	CESI 03 ATEX 174X		
	IEC Ex	CES 16.0015X	Para todos los datos de certificación IEC Ex, descargue el certificado de la página web <a href="http://www.cortemgroup.com">www.cortemgroup.com</a>	
	TR CU	AVAILABLE	All TR CU certification data can be downloaded from <a href="http://www.cortemgroup.com">www.cortemgroup.com</a>	
<b>Standards:</b>	CENELEC EN 60079-0: 2013, EN 60079-1: 2014, EN 60079-11: 2012, EN 60079-26: 2015, EN 60079-31: 2014 and EUROPEAN DIRECTIVE 2014/34/UE			
 <b>Ambient Temp.:</b>	 -20°C	 +40°C	With temperature class T6 and maximum surface temperature T85°C.	
	 -20°C	 +55°C	With temperature class T5 and maximum surface temperature T100°C.	
	 -60°C		On request.	
<b>Degree of protection:</b>	IP66			



**ORIGINAL PRODUCT**

## MECHANICAL FEATURES

<b>Body and lid:</b>	Low copper content aluminium alloy. Screw-on lid with safety fastening grub screw
<b>Gasket:</b>	Resistant to acids, hydrocarbons and high temperatures, located between body and lid
<b>Certification label:</b>	Adhesive label located inside on empty enclosures; aluminium label riveted onto body on other versions
<b>Bolts and screws:</b>	Stainless steel
<b>Earth screws:</b>	Stainless steel. On inside and outside of body complete with anti-rotation brackets
<b>Mounting:</b>	Cast aluminium feet
<b>Coating:</b>	Polyester coating RAL 7035 (Light grey)
<b>Corrosion Resistance:</b>	The STANDARD of the aluminium alloy used by Cortem has passed the tests required by standards EN 60068-2-30 (hot/humid cycles) and EN 60068-2-11 (salt mist tests)

## ACCESSORIES AVAILABLE ON REQUEST/ SPECIAL REQUESTS

- Internal anti-condensation coating RAL 2004 (pure orange)
- Possible drilling of the enclosure bottom
- Breather valve Code ECD-210S
- Drain valve Code ECD-210S
- External polyester coatings in different colour
- CCA-...EH series enclosures with round viewing window on lid
- Internal mounting plate:
  - 2.5mm-thick aluminium (code TF-...E). See accessories section
  - 2.5mm-thick electrogalvanized steel (code TF-...EAC)
- Thread options:
  - NPT threads ANSI B1.20.1
  - GAS UNI ISO 7-1 thread
  - Metric threads ISO 261/965

# CCA-...E series Aluminium junction boxes gas group IIC

## ENCLOSURE SELECTION CHART

Code	Outside dimensions				Inside dimensions					Mounting			Weight kg
	A	B	C	ØB1	a	b	c	Ød1	s	E	F	ØG	
CCA-0E	128	128	133	146	104	104	75	130x2	12	111	138	9	2,1
CCA-01E	145	145	135	170	121	121	75	150x2	12	128	150	9	2,6
CCA-02E	195	195	159	220	171	171	83	200x3	12	175	175	10	4,9
CCA-03E	240	240	228	270	216	216	154	250x3	12	213	213	12	8,7
CCA-04E	385	385	294	410	353	353	156	390x3	16	339	339	14	25

## DIMENSIONAL DRAWING

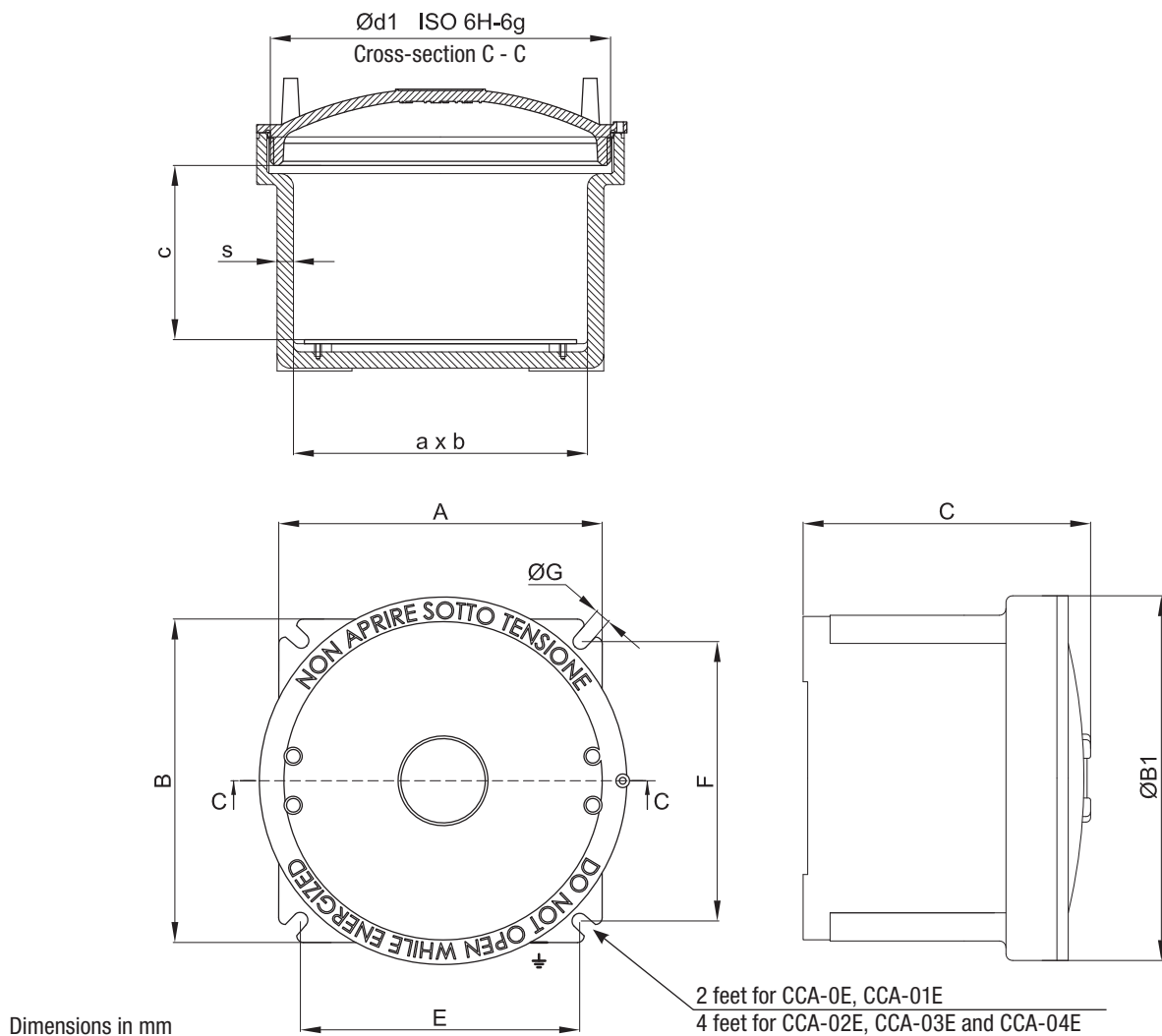

# CCA-...E series Body drilling data

THREAD COMPARISON CHART									
ISO 7-1	1/2"	3/4"	1"	1 1/4"	1 1/2"	2"	2 1/2"	3"	4"
ANSI B.20.1 NPT	1/2"	3/4"	1"	1 1/4"	1 1/2"	2"			
ISO 261/965	20x1.5	25x1.5	32x1.5	40x1.5	50x1.5	63x1.5	75x1.5	90x1.5	100x1.5
<b>D</b> Thread diameter	<b>1</b>	<b>2</b>	<b>3</b>	<b>4</b>	<b>5</b>	<b>6</b>	<b>7</b>	<b>8</b>	<b>10</b>

As required by the current standard, holes can be drilled by Cortem or by authorized partners who hold a production notification in accordance with ATEX Directive .



TYPE OF ENCLOSURE	HOLE DRILLING IN BODY									
	One side									
	Drilling area mm	MAXIMUM QUANTITY PER HOLE TYPE								
1		2	3	4	5	6	7	8	10	
CCA-0E	95x65	4	4	2	1	1	1	-	-	-
CCA-01E	108x65	6	4	3	2	1	1	-	-	-
CCA-02E	130x65	8	6	3	2	2	1	-	-	-
CCA-03E	155x115	12	12	6	6	4	2	1	1	1
CCA-04E	243x140	28	22	15	12	8	6	3	2	2

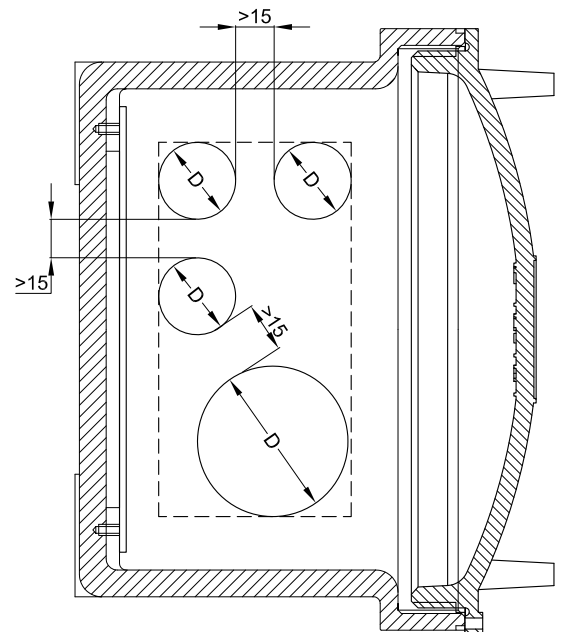





# CCA-...E series Features of junction boxes with terminals

Examples of terminal strips with minimum installation distances

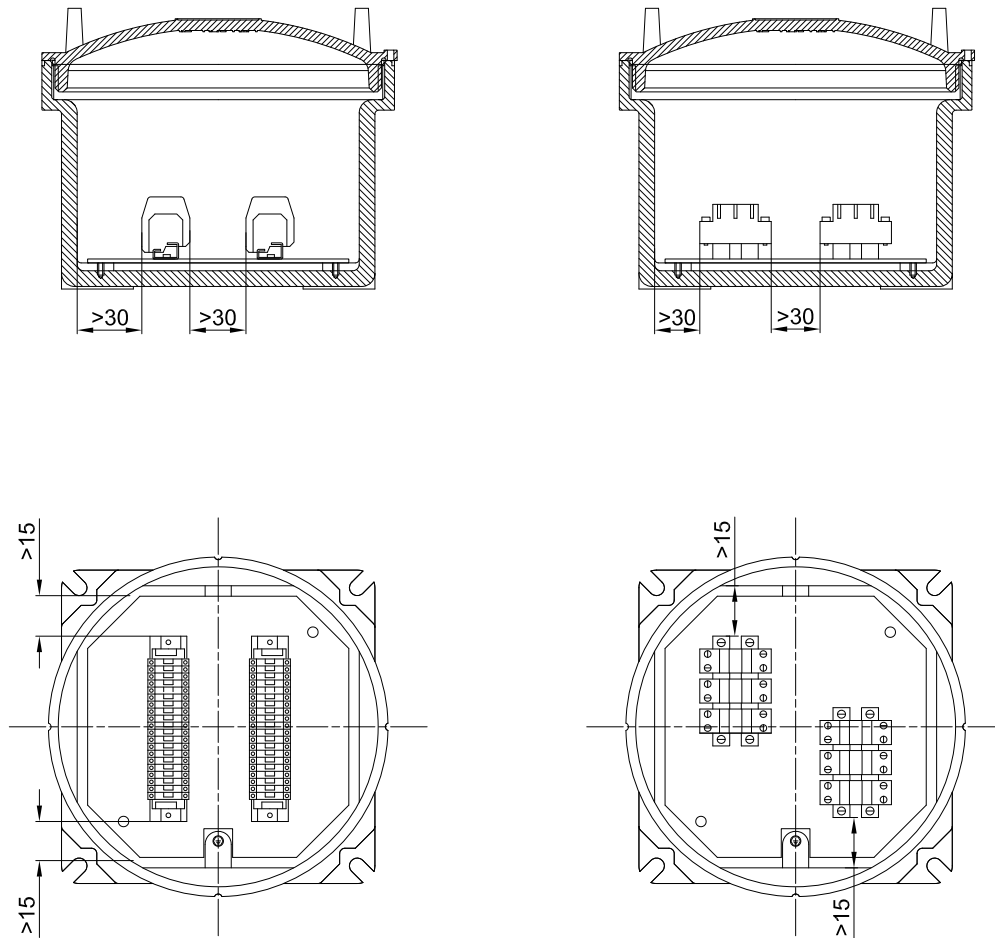

TYPE OF ENCLOSURE	MAXIMUM NUMBER OF TERMINALS HOUSED								
	TERMINAL CROSS-SECTIONAL AREA								
	2.5	4	6	10	16	35	70	120	185
CCA-0E	13	12	8	7	6	-	-	-	-
CCA-01E	17	14	11	9	7	5	-	-	-
CCA-02E	2x22	2x19	2x15	2x12	2x10	6	-	-	-
CCA-03E	2x32	2x27	2x22	2x17	2x14	8	-	-	-
CCA-04E	3x40	3x30	2x28	2x23	2x18	12	10	6	4

Eg. 2x22= 2 rows of 22 terminals (total 44 terminals). The maximum number of standard terminals refers to the mounting of CABUR terminals

## Features of junction boxes for control, monitoring and signalling units

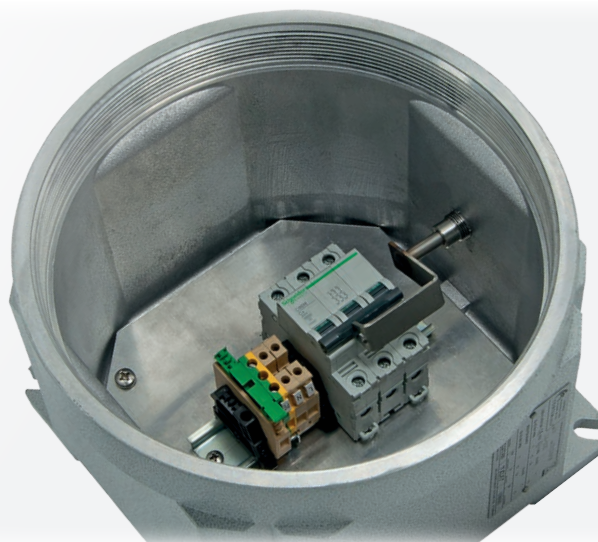

Control, monitoring and signalling units are used to produce control boards that, when positioned near the electrical equipment being controlled, enable the electrical system to operate correctly and guarantee the safety of personnel when maintenance is being performed on the system. Because they are fitted with a Manual/Automatic selector, they allow operators to select the appropriate conditions to enable work to be performed entirely safely. They offer protection and control for electrical equipment and control circuits located in explosion hazard areas and in particularly aggressive environments. They are used to hold electrical equipment, such as switches, indicators, contactors, transformers, analogue and digital components, etc.... with the option of external control by using body-mounted Cortem control and signalling devices, such as control levers, pushbuttons, indicator lights, etc.... Cortem designs, develops and supplies full cabling for one or more enclosures tailored to your specific requirements, producing panel boards - including even extremely complex solutions - and providing a full inspection and testing service on request.

### ELECTRICAL FEATURES

<b>Rated voltage:</b>	24 / 1000 Vac	12 / 250 Vdc
<b>Max. current on contacts:</b>	650 A	
<b>Rated frequency:</b>	50 / 60Hz	

### Features of equipment that can be installed inside enclosures to produce control and monitoring units.

Table of standard electrical features of components that can be installed in enclosures to produce control, monitoring and signalling units.

(The values refer to the catalogues of the leading manufacturers of electrical/electronic components available on the market)

COMPONENT TYPE	Max. V (Volts)	Max. I (Amperes)	Max. power (Watts)
Analogue and digital instruments	660	5	10
Electronic inverters/reactors	400	-	10
PLCs Multiplexers and amplifiers	240	-	80
Testing and measuring devices	240	-	100
Circuit breakers	660	650	-
Fuses	660	400	-
Relays	500	10	12
Electronic control devices	660	-	100
Contactors	660	650	30
Timers	240	10	5
Twilight relays	240	-	2
Capacitors	660	-	-
Transformers	660	-	200
Resistors	240	-	300
Terminals	660	-	-
Reactors	277	7.5	40

### Minimum air gap between components

Component voltage (V ac)	Min. air gap (mm)
60 - 250	6
250 - 380	8
380 - 500	10
500 - 660	12
660 - 1000	20
Component voltage (V dc)	Min. air gap (mm)
12 - 250	6

# Features of junction boxes for control, monitoring and signalling units

## Example of internal layout for CCA-...E series enclosures. - Minimum distances -

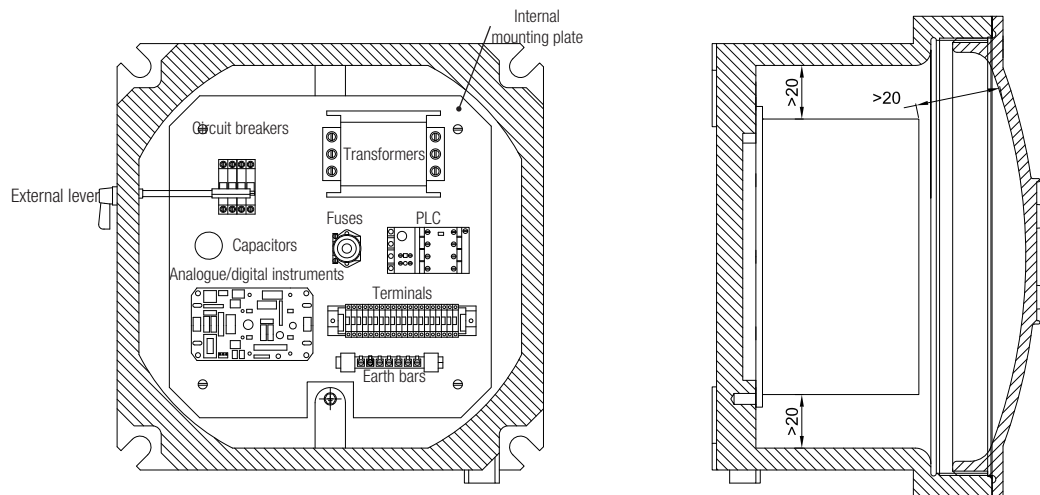

Minimum distances for 630/650A switches and contactors

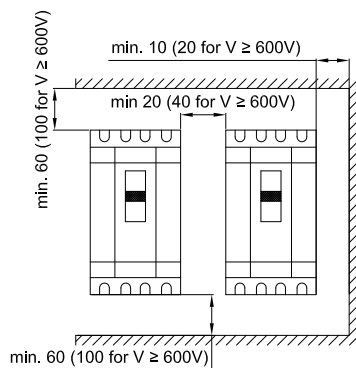

## Identification and description of special equipment that is suitable for installation inside.

### Enclosures with batteries

Option of installing low-capacity batteries  $\leq 1.5\text{Ah}$ , for powering small electronic devices or backup memories. Whatever the case, the minimum distance of 20mm between the components installed and the inside walls of the enclosure must be met.

### Enclosures with surge arresters

Option of installing PRD or similar types of surge arresters, with a maximum protection limit of 65kA; whatever the case, the minimum distance of 20 mm between the arrester and the inside walls of the enclosure must be met.

### Enclosures with fibre-optic cables

The enclosures have provision for feeding multiple (not single) fibre-optic cables in and out. The permitted optical power and radiation limits for optical cables are:

- 35mW and 5mW/m<sup>2</sup> for T4 temperature class
- 15mW and 5mW/m<sup>2</sup> for T6 temperature class

### Enclosures with radio-frequency sources

Option of installing components with radio-frequency sources in the 9kHz to 60GHz range that can be used for continuous and pulsed transmission of signals. Antennas can be installed inside or outside the enclosure and must:

- comply with one of the protection types indicated in standard EN 60079-0
- be installed outside the hazardous area.

For more information, refer to certificate CESI 01 ATEX 036X.

# Features of junction boxes for control, monitoring and signalling units

## Table with maximum power dissipation values for CCA-...E series enclosures.

The temperature classes and maximum surface temperatures of control and monitoring unit enclosures depend on the size of the enclosure, ambient temperature and power dissipation inside the enclosure.

Enclosure type		Maximum power dissipation (Watts) with ambient temperature of +40°C		
		T6 class without indicator lights. Only indicator LEDs are allowed	T5 class with indicator lights and/or LEDs	T5 class without indicator lights. Only indicator LEDs are allowed
CCA-0E	CCA-0EH	8	9	13
CCA-01E	CCA-01EH	11	12	17
CCA-02E	CCA-02EH	23	25	36
CCA-03E	CCA-03EH	40	44	58
CCA-04E	CCA-04EH	93	100	164

Enclosure type		Maximum power dissipation (Watts) with ambient temperature of +55°C		
		T6 class without indicator lights. Only indicator LEDs are allowed	T5 class with indicator lights and/or LEDs	T5 class without indicator lights. Only indicator LEDs are allowed
CCA-0E	CCA-0EH	6	7	9
CCA-01E	CCA-01EH	9	10	13
CCA-02E	CCA-02EH	20	22	28
CCA-03E	CCA-03EH	29	32	43
CCA-04E	CCA-04EH	70	77	125

Example of panel with CCA-03E enclosure with 220/24V transformer and fuses for Cortem PY-216V socket and SPY-216V plug complete with SA141410 enclosure with connection terminal strip

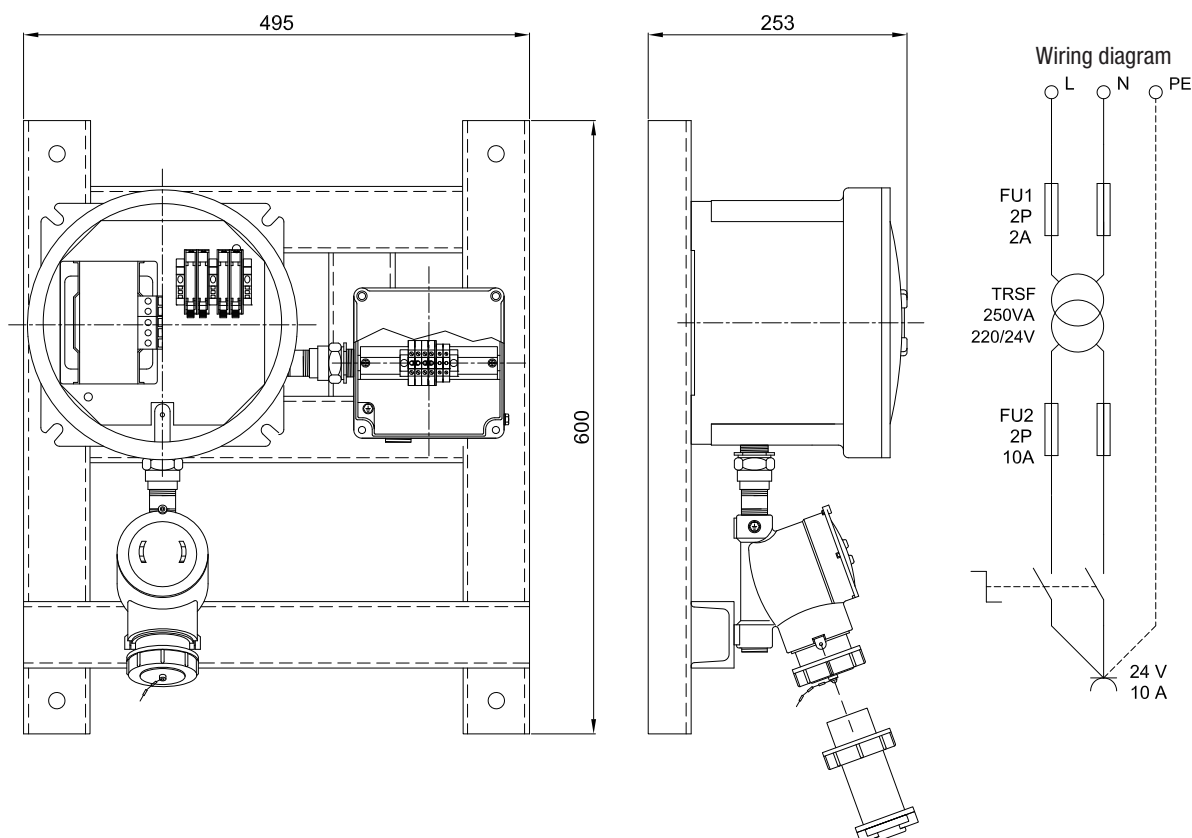

## ELECTRICAL FEATURES

<b>Rated voltage:</b>	24 / 1000 Vac	12 / 250 Vdc
<b>Max. current on contacts and fuses:</b>	400 A	
<b>Rated frequency:</b>	50 / 60Hz	

## GENERAL INSTALLATION INFORMATION

The maximum power dissipation inside the enclosure depends on the maximum current on contacts and fuses, the size of the enclosure, the temperature class (or maximum surface temperature for 2GD category) and ambient temperature, as specified in the maximum power dissipation tables (see previous page).

The maximum power dissipation must not exceed the values given in the table when non-'Ex i' components and 'Ex i' components (with 1.1 W maximum power dissipation) are installed together.

The maximum power dissipation possible inside the enclosure will also depend on the maximum power dissipation of terminals, contacts and cables; whatever the case, the current density value allowed in the enclosure is prescribed by EN 60439-1, IEC 60439-1.

### Details of barrier mounting inside enclosures

The "omega" rail, in accordance with EN 60079-11, is suitable for mounting barriers inside 'Ex d' enclosures.

Barriers are mounted (according to the manufacturer's directions) 7.5 mm away from the base of the enclosure and are secured to the DIN rail with 2 earth terminals (nominal cross-sectional area 6-10 mm) and 2 standard terminals for omega rails (EN 60079-11).

Up to how many barriers can be installed in the enclosures will depend on the properties of the barriers in question; in addition, the maximum number of barriers must not exceed the limit allowed by the certificate in any case.

Associated equipment can also be mounted on a DIN rail; when it is mounted on the enclosure's internal mounting plate, reference must be made to the minimum prescribed distances. Whether mounted on a rail or mounting plate, associated equipment must meet the following requirements:

#### Separators

When separators are used, they must be appropriately sized; their thickness and fastening inside the enclosure must be suitably determined and separators must allow air to circulate inside the enclosure.

#### Incoming cables

Incoming cables for 'Ex i' circuits must be suitably labelled or the area around the entry must be coloured blue RAL 5015. 'Ex i' entries must be clearly identified.

#### Installation of 'Ex i' and non-'Ex i' components inside the enclosure.

Ex d IIC certified enclosures complete with accessories can contain only Ex ia IIC associated equipment. In this case, the resulting version becomes Ex d [ia] IIC.

#### Connection of internal cables

Cables are connected inside the enclosure to the barriers in accordance with EN 60079-11, with one side for connecting 'Ex i' cables and the opposite side for connecting non-'Ex i' cables.

Connection in 'Ex i' circuits must be made using insulated cables only; there must be no connections to non-'Ex i' circuits and no more than one cable can be connected to a single terminal. 'Ex i' cables cannot be grouped together with non-'Ex i' cables. In addition, 'Ex i' cables and non-'Ex i' cables must be kept separate. The minimum distance between the 2 types of cables must be 8 mm. The minimum insulation level for non-'Ex i' cables must be greater than 1.5 kV; the minimum insulation level for 'Ex i' cables must be greater than 0.5 kV.

#### Internal connections

When routing cables belonging to 'Ex i' circuits, the cables must be identified in one of the following ways:

- cables must have blue insulation (as long as there are no other cables inside the enclosure with this colour).
- 'Ex i' cables must be kept separate from non-'Ex i' cables with blue cable raceways.
- 'Ex i' cables must be grouped together, using a tie, for example, and the area identified with a blue label.

#### Warning 'Ex i' circuits

- cables for power circuits must have a cross-sectional area of at least 1.5 mm<sup>2</sup>.
- 'Ex i' circuits must be kept at a distance of 50 mm from non-'Ex i' circuits.
- the earth connection must meet European standard EN 60079-14.

# CCA-...E series Features of junction boxes with interface units

The number of items of equipment mounted inside the enclosures and their layout will vary based on the following:

- in accordance with standards EN 60079-1 and IEC 60079-1, the equipment contained inside the enclosure can be arranged in any way provided that at least 20% of the surface area of each section is left free.
- equipment must be set at a suitable distance to accommodate cable wiring.

**Example of interface unit without separator**

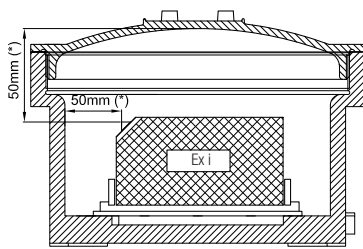

**Example of interface unit (with associated equipment) complete with separator**

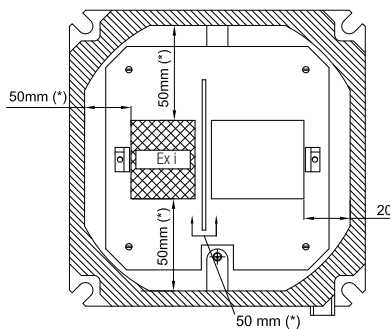
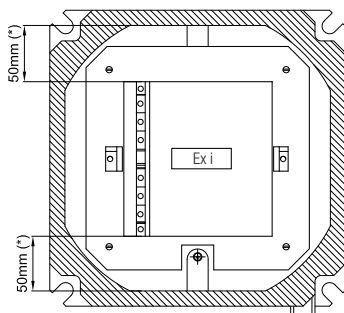
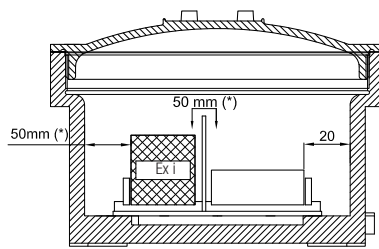

**NOTES**

(\*) 50 mm is the minimum safe distance between 'Ex i' components and non-'Ex i' components (and/or conducting parts).

- The active and passive barriers that can be installed in the enclosures must have their own ATEX certificate.
- The maximum voltage entering barriers on non-'Ex i' circuits must be less than 250 V.

**Examples of installation of associated equipment - minimum distances.**

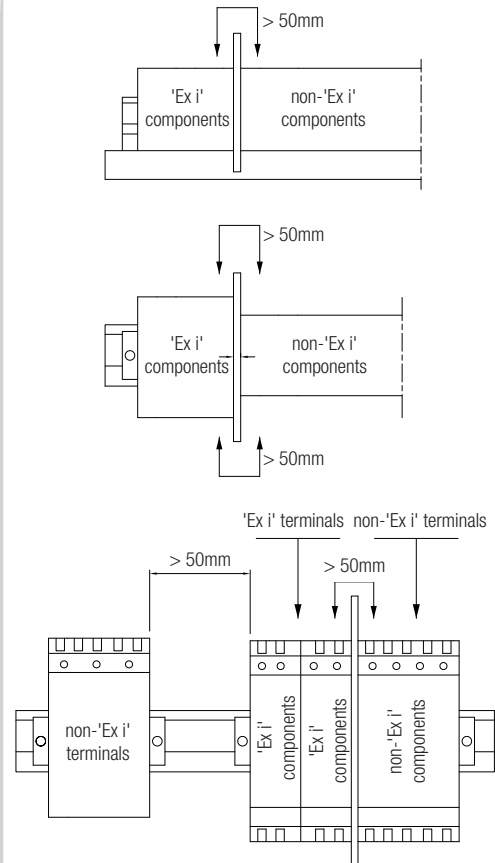

**DON'T FORGET TO ORDER THE ACCESSORIES**

Example: Enclosure type CCA-03E + Internal mounting plate TF-03E + Cable glands, unions + other...see key



## CCA-...EH series Junction boxes with round viewing windows

CCA-...EH series junction boxes are used as enclosures for electrical equipment that requires a visual interface with the outside. Voltmeters, ammeters and other analogue and digital measuring instruments are typical examples of installations that require a window for taking direct readings. These enclosures are also used to house monitoring instruments such as infra-red photoelectric cells and twilight sensors that provide pulses for control and signalling equipment (opening/closing, alarms, etc...). Our technical department will decide what size enclosures to use based on your requirements and determine the internal layout so that all the dimensional and electrical parameters prescribed by the certificate are met. We can install equipment to your specifications within the technical limits allowed by the certificate and based on our standard control and signalling devices.





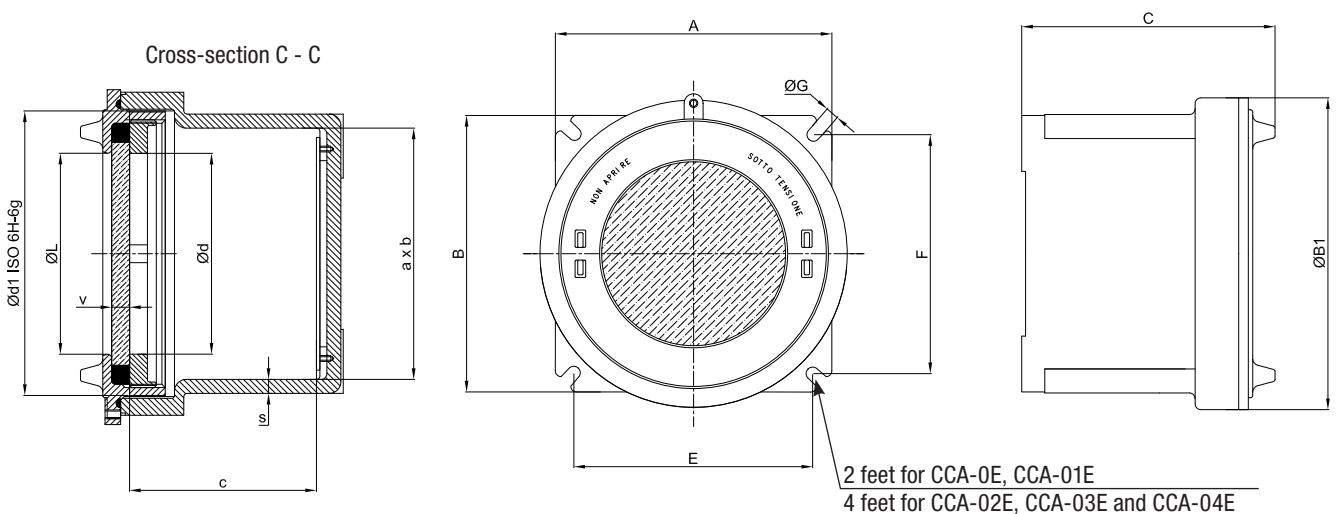







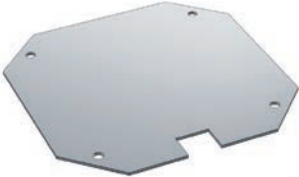

**DIMENSIONAL DRAWING OF ENCLOSURES WITH ROUND VIEWING WINDOWS**



### ENCLOSURE SELECTION CHART

Code	Outside dimensions mm					Inside dimensions mm							Mounting mm			Weight kg
	A	B	C	ØB1	ØL	a	b	c	Ød	Ød1	s	v	E	F	ØG	
CCA-0EH	128	128	130	146	90	104	104	85	90	130x2	12	10	111	142	9	
CCA-01EH	145	145	155	160	90	121	121	105	92	150x2	12	10	128	150	9	
CCA-02EH	195	195	150	212	140	171	171	95	140	200x2	12	12	175	175	10	
CCA-03EH	240	240	210	260	180	216	216	154	180	240x3	12	15	213	213	12	
CCA-04EH	385	385	277	410	310	353	353	190	310	390x3	16	20	339	339	14	

# CCA-...E, CCA-...EH series Accessories available on request and spare parts

ILLUSTRATION	DESCRIPTION	MODEL	FEATURES	CODE	KEY
	Internal mounting plates	CCA-0E, CCA-0EH	Thickness 2.5mm  Aluminium (TF-...) Galvanized steel (TF-...AC)	TF-0E	 
		CCA-01E, CCA-01EH		TF-01E	
		CCA-02E, CCA-02EH		TF-02E	
		CCA-03E, CCA-03EH		TF-03E	
		CCA-04E, CCA-04EH		TF-04E	
	Breather and drain valve	Thread diameter ISO 7-R 3/8"	Material: stainless steel	ECD-210S	 
	Cable glands and unions		For models and codes, visit <a href="http://www.cortemgroup.com">www.cortemgroup.com</a>		 
	Viewing window	CCA-0EH	Shock and high temperature resistant borosilicate glass sealed in aluminium ring	K-0253	 
		CCA-01EH		K-0145	
		CCA-02EH		K-0254	
		CCA-03EH		K-0255	
		CCA-04EH		K-0195	

Enclosures	Internal mounting plates				Code
	A	B	a	b	
CCA-0E	100	100	80	60	TF-0E
CCA-01E	113	113	90	90	TF-01E
CCA-02E	150	150	120	120	TF-02E
CCA-03E	200	200	145	145	TF-03E
CCA-04E	270	270	230	230	TF-04E

