

Floodlight LED

Series 6125/2

E2



- LED high-performance floodlight with a power consumption up to 225 W
- Wide voltage input between 110 V and 277 V (50 Hz and 60 Hz)
- Suitable for operation using central battery systems and mains DC (176 V to 264 V DC)
- Three power classes available: 100 W, 160 W and 225 W
- An enclosure made of 316L stainless steel is available for marine and offshore applications

WebCode **6125B**



The new generation of LED floodlights for Zone 1 also relies on the tried-and-tested, robust stainless steel enclosure (optionally seawater-resistant stainless steel 316L). However, thanks to their smaller design and a new generation of drivers, they weigh significantly less, thereby improving ergonomics during installation and operation. Now with three power classes and the three tried-and-tested light distribution curves, the LED floodlight generates three colours of LED light – warm white, neutral white and cold white.

	IECEX / ATEX					
Zone	0	1	2	20	21	22
Installation in		•	•		•	•

Selection Table							
Colour temperature	4000 K						
Light colour	Warm white						
Colour rendering	≥ 80						
Enclosure material	Light distribution	Lamp wattage	Luminous flux	Luminaire efficacy	Product Type	Art. No.	Weight kg
Stainless steel 1.4301, Powder-coated Single-layer powder-coated	Medium-beam	160 W	14888 lm	96 lm/W	6125/2122-3501-6014-331	284569	18.500
	Narrow-beam	225 W	20757 lm	94 lm/W	6125/2121-5501-6014-331	284581	19.000
		100 W	9860 lm	99 lm/W	6125/2124-1501-6014-331	284567	16.500
	Wide beam	160 W	14097 lm	91 lm/W	6125/2124-3501-6014-331	284568	18.500
		225 W	19261 lm	88 lm/W	6125/2124-5501-6014-331	284570	19.000
Stainless steel 1.4404, Powder-coated Double powder-coated	Medium-beam	160 W	14888 lm	96 lm/W	6125/2122-3501-6014-242	284584	18.500
	Narrow-beam	225 W	20757 lm	94 lm/W	6125/2121-5501-6014-242	284586	19.000
		100 W	9860 lm	99 lm/W	6125/2124-1501-6014-242	284582	16.500
	Wide beam	160 W	14097 lm	91 lm/W	6125/2124-3501-6014-242	284583	18.500
		225 W	19261 lm	88 lm/W	6125/2124-5501-6014-242	284585	19.000

Floodlight LED

Series 6125/2

E2

Selection Table							
Colour temperature		5000 K					
Light colour		Neutral white					
Colour rendering		≥ 80					
Enclosure material	Light distribution	Lamp wattage	Luminous flux	Luminaire efficacy	Product Type	Art. No.	Weight kg
Stainless steel 1.4301, Powder-coated Single-layer powder-coated	Medium-beam	160 W	15413 lm	99 lm/W	6125/2122-3501-6015-331	284564	18.500
	Narrow-beam	225 W	21490 lm	98 lm/W	6125/2121-5501-6015-331	284566	19.000
		100 W	10208 lm	102 lm/W	6125/2124-1501-6015-331	284562	16.500
	Wide beam	160 W	14595 lm	94 lm/W	6125/2124-3501-6015-331	284563	18.500
		225 W	19941 lm	91 lm/W	6125/2124-5501-6015-331	284565	19.000
Stainless steel 1.4404, Powder-coated Double powder-coated	Medium-beam	160 W	15413 lm	99 lm/W	6125/2122-3501-6015-242	282404	18.500
	Narrow-beam	225 W	21490 lm	98 lm/W	6125/2121-5501-6015-242	282406	19.000
		100 W	10208 lm	102 lm/W	6125/2124-1501-6015-242	282402	16.500
	Wide beam	160 W	14595 lm	94 lm/W	6125/2124-3501-6015-242	282403	18.500
		225 W	19941 lm	91 lm/W	6125/2124-5501-6015-242	282405	19.000
Colour temperature		5700 K					
Light colour		Cool white					
Colour rendering		≥ 70					
Enclosure material	Light distribution	Lamp wattage	Luminous flux	Luminaire efficacy	Product Type	Art. No.	Weight kg
Stainless steel 1.4301, Powder-coated Single-layer powder-coated	Medium-beam	160 W	17444 lm	113 lm/W	6125/2122-3501-6011-331	282394	18.500
	Narrow-beam	225 W	24562 lm	111 lm/W	6125/2121-5501-6011-331	282396	19.000
		100 W	11574 lm	116 lm/W	6125/2124-1501-6011-331	282392	16.500
	Wide beam	160 W	16631 lm	107 lm/W	6125/2124-3501-6011-331	282393	18.500
		225 W	22654 lm	103 lm/W	6125/2124-5501-6011-331	282395	19.000
Stainless steel 1.4404, Powder-coated Double powder-coated	Medium-beam	160 W	17444 lm	113 lm/W	6125/2122-3501-6011-242	282399	18.500
	Narrow-beam	225 W	24562 lm	111 lm/W	6125/2121-5501-6011-242	282401	19.000
		100 W	11574 lm	116 lm/W	6125/2124-1501-6011-242	282397	16.500
	Wide beam	100 W	11574 lm	116 lm/W	6125/2124-1501-6021-242	282407	16.500
		160 W	16631 lm	107 lm/W	6125/2124-3501-6011-242	282398	18.500
225 W	22654 lm	103 lm/W	6125/2124-5501-6011-242	282400	19.000		

Technical Data			
Variant	Floodlight LED 100 W	Floodlight LED 160 W	Floodlight LED 225 W
Explosion Protection			
IECEX gas explosion protection	Ex db eb op is IIC T4 Gb	Ex db eb op is IIC T4 Gb	Ex db eb op is IIC T4 Gb
IECEX dust explosion protection	Ex tb op is IIIC T100 °C Db	Ex tb op is IIIC T100 °C Db	Ex tb op is IIIC T100 °C Db
ATEX gas explosion protection	Ⓜ II 2 G Ex db eb op is IIC T4 Gb	Ⓜ II 2 G Ex db eb op is IIC T4 Gb	Ⓜ II 2 G Ex db eb op is IIC T4 Gb
ATEX dust explosion protection	Ⓜ II 2 D Ex tb op is IIIC T100 °C Db	Ⓜ II 2 D Ex tb op is IIIC T100 °C Db	Ⓜ II 2 D Ex tb op is IIIC T100 °C Db

Floodlight LED

Series 6125/2

E2

Technical Data			
Variant	Floodlight LED 100 W	Floodlight LED 160 W	Floodlight LED 225 W
Explosion Protection			
Certificates	ATEX (BVIS), Brazil (ULB), IECEx (BVIS), India (PESO)	ATEX (BVIS), Brazil (ULB), IECEx (BVIS), India (PESO)	ATEX (BVIS), Brazil (ULB), IECEx (BVIS), India (PESO)
Electrical Data			
Rated operational voltage AC	110 – 277 V	110 – 277 V	110 – 277 V
Frequency range	50 – 60 Hz	50 – 60 Hz	50 – 60 Hz
Ambient Conditions			
Ambient temperature	-50 °C ... +60 °C	-60 °C ... +60 °C	-60 °C ... +60 °C
Min. ambient temperature note	Energise above -40 °C	Energise above -40 °C	Energise above -40 °C
Storage temperature	-40 °C ... +75 °C	-40 °C ... +75 °C	-40 °C ... +75 °C
Lighting Data			
Lamp	LED	LED	LED
Mechanical Data			
Degree of protection (IP)	IP66	IP66	IP66
Class	I	I	I
Sealing material	Silicone	Silicone	Silicone
Pane material	Reinforced glass	Reinforced glass	Reinforced glass
Max. solid connection terminals	6 mm ²	6 mm ²	6 mm ²
Impact strength (IEC 62262)	IK10	IK10	IK10
Fastening	With bracket, SS316L	With bracket, SS316L	With bracket, SS316L
Components			
Cable glands and entries	1 x M25 x 1.5 CMP-25A2F	1 x M25 x 1.5 CMP-25A2F	1 x M25 x 1.5 CMP-25A2F

Light Distribution Curves – Subject to Alterations

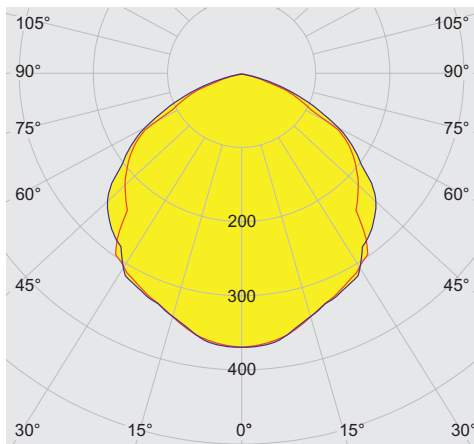

cd/klm 100%
 — C0 - C180 — C90 - C270
 typ. broad beam

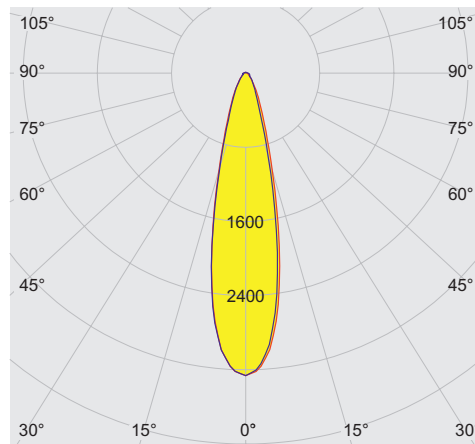

cd/klm 100%
 — C0 - C180 — C90 - C270
 typ. narrow beam

Floodlight LED

E2

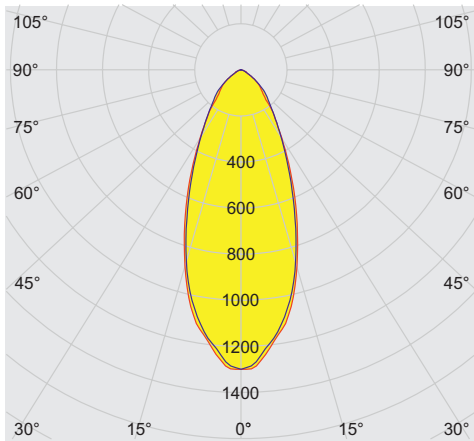

cd/klm 100%
 — C0 - C180 — C90 - C270

typ. medium beam

Accessories

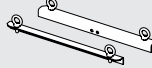
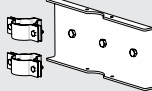
Figure	Description	Art. No.	Weight kg
Mounting bracket			
	Stainless steel SS304 (1.4301 or V2A) without powder coating	269731	3.130
	Stainless steel SS316L (1.4404 or V4A) without powder coating	221589	3.130
Mounting set			
	for pendant mounting with ring bolts included - stainless steel SS316L (1.4404 or V4A) without powder coating	257464	1.500
	for pole mounting with pole diameter of 50 mm - stainless steel SS316L (1.4404 or V4A) without powder coating	283361	5.000
	for pole mounting with pole diameter of 60 mm - stainless steel SS316L (1.4404 or V4A) without powder coating	263824	5.000

Dimensional Drawings (All Dimensions in mm [inches]) – Subject to Alterations

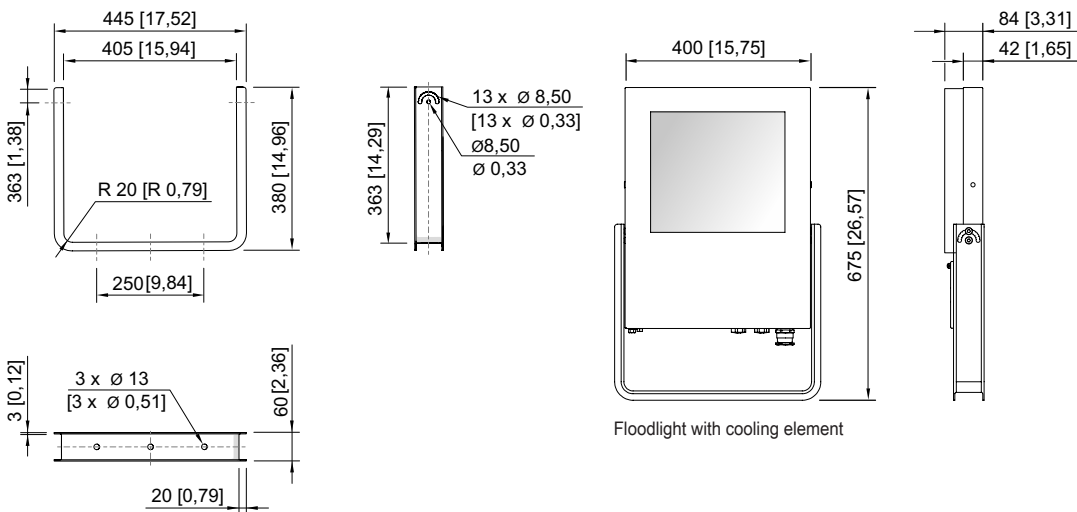

Mounting bracket

Floodlight LED

Series 6125/2

E2

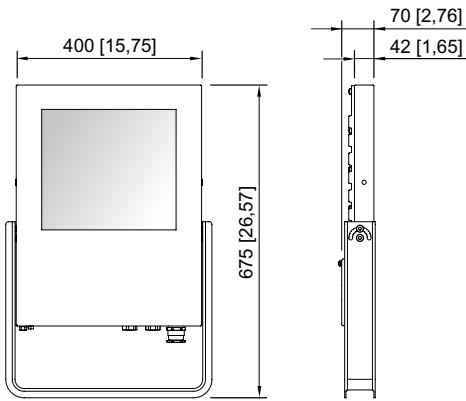

Floodlight without cooling element

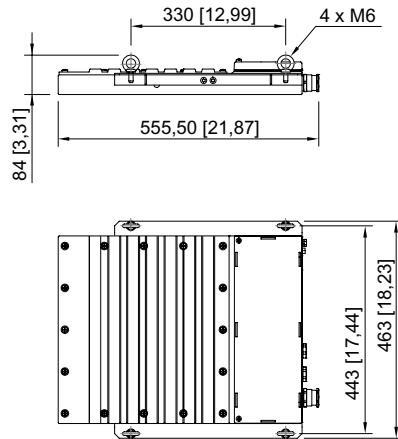

Floodlight without cooling element, with ring eyes

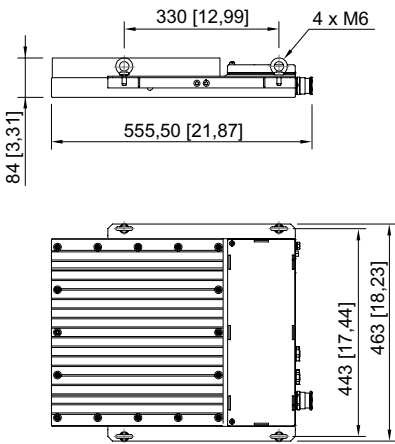

Floodlight with cooling element, with ring eyes

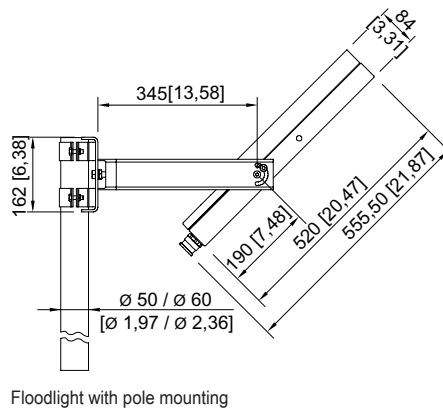

Floodlight with pole mounting

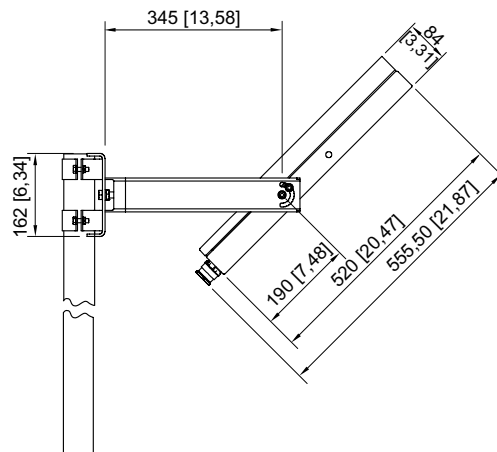
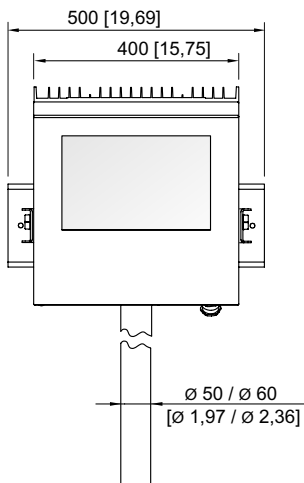
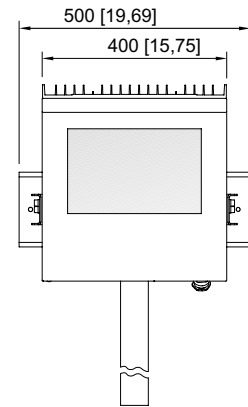

Floodlight LED

Series 6125/2

E2

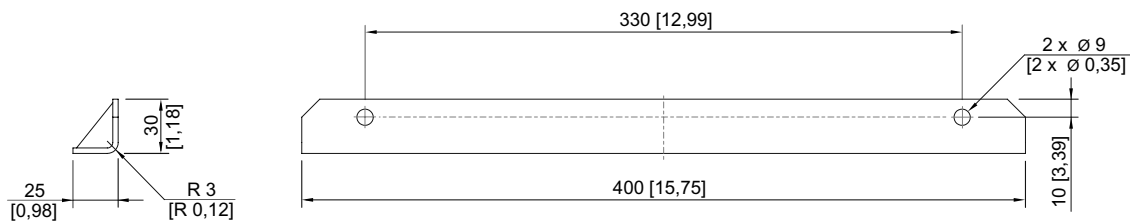
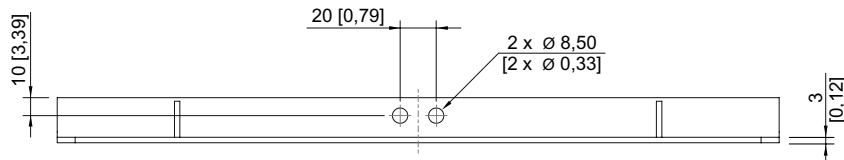
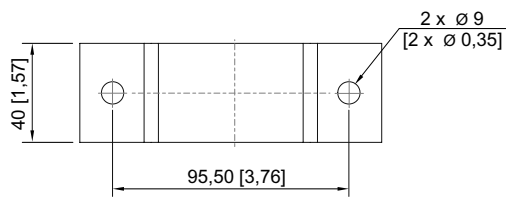
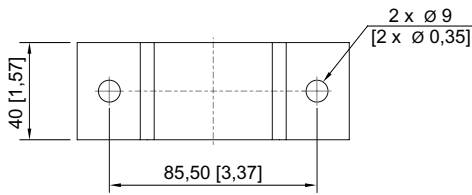
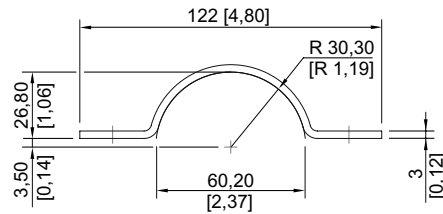
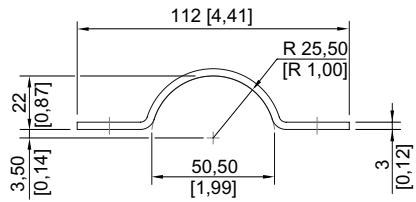
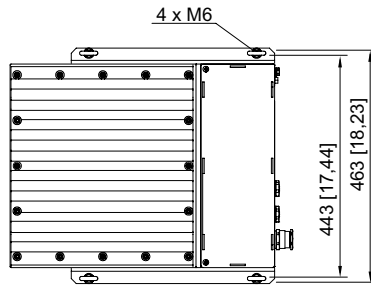
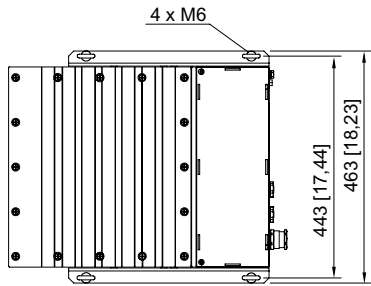
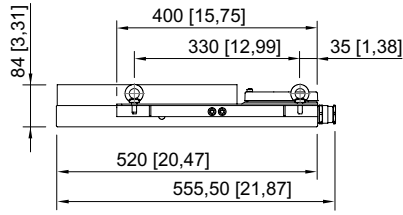
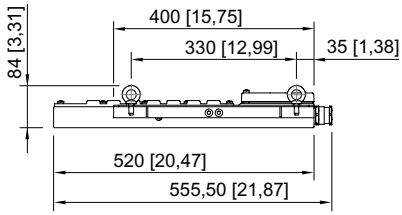

Floodlight LED

Series 6125/2

E2

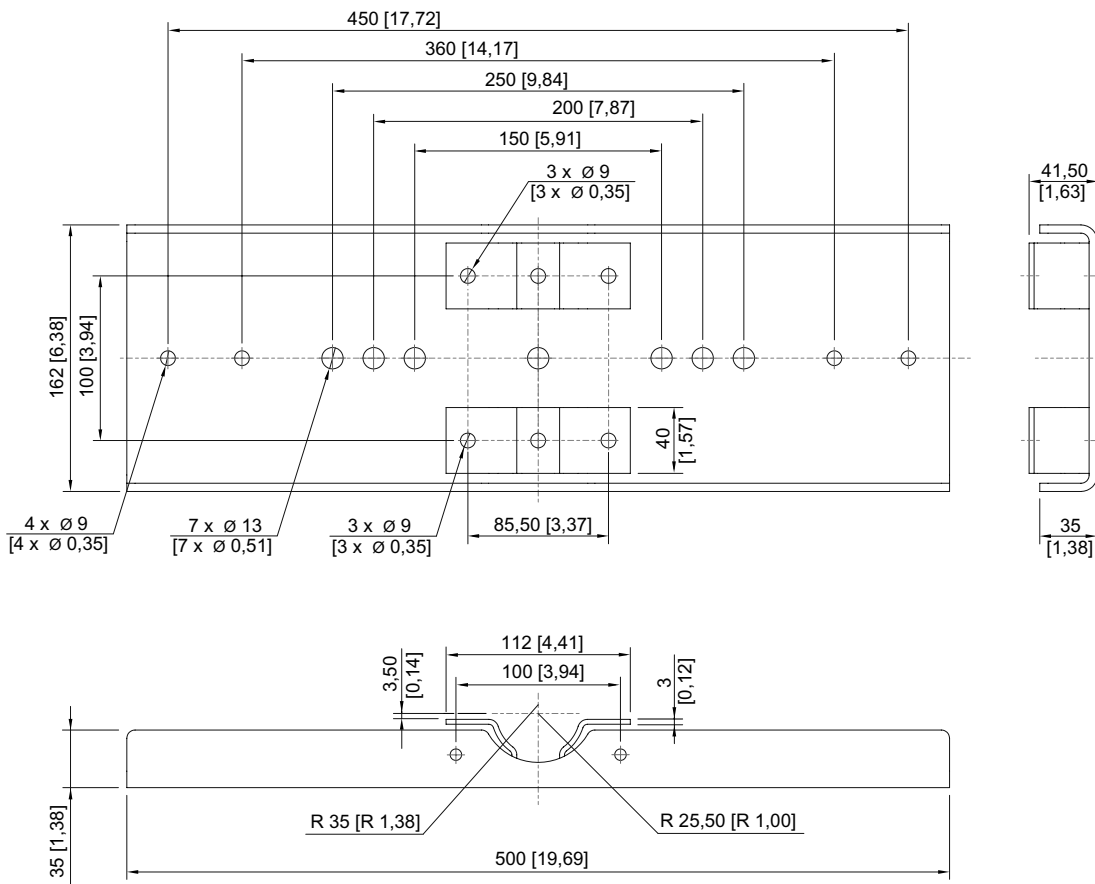

Floodlight LED

Series 6125/2

E2

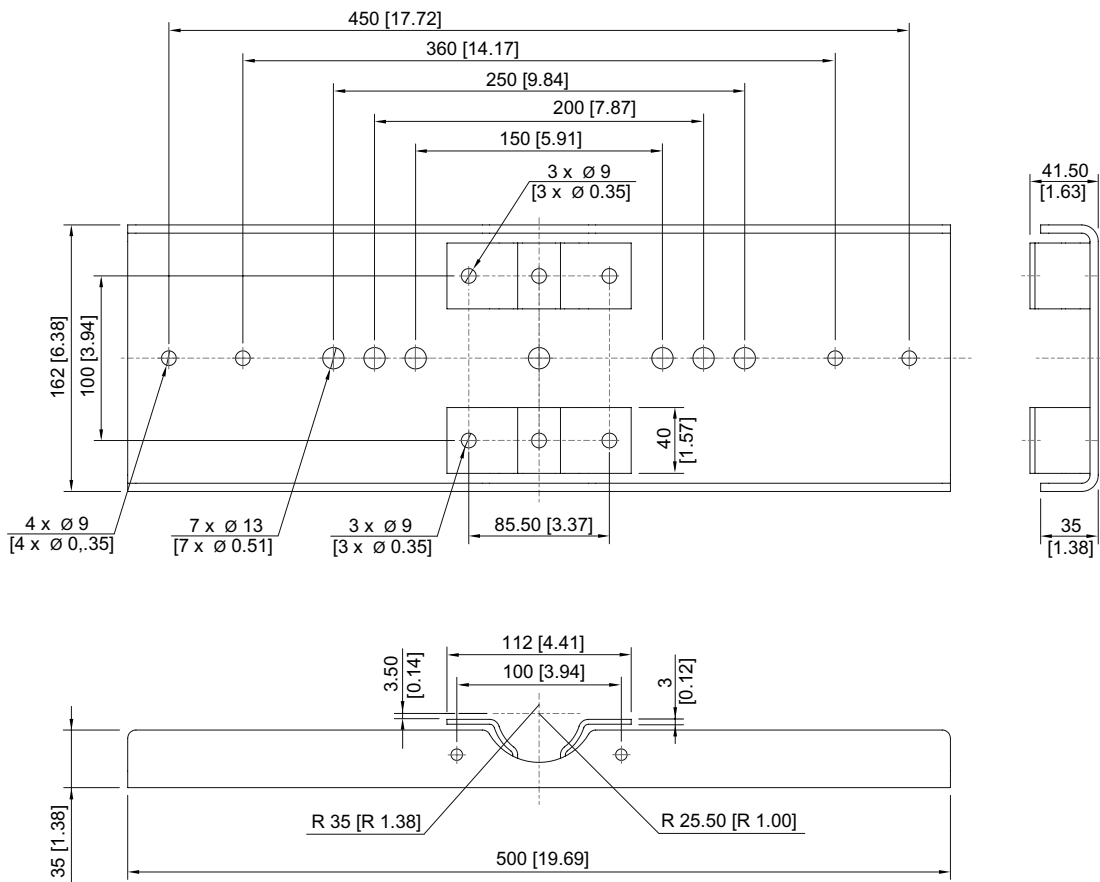

Floodlight LED

Series 6125/2

E2

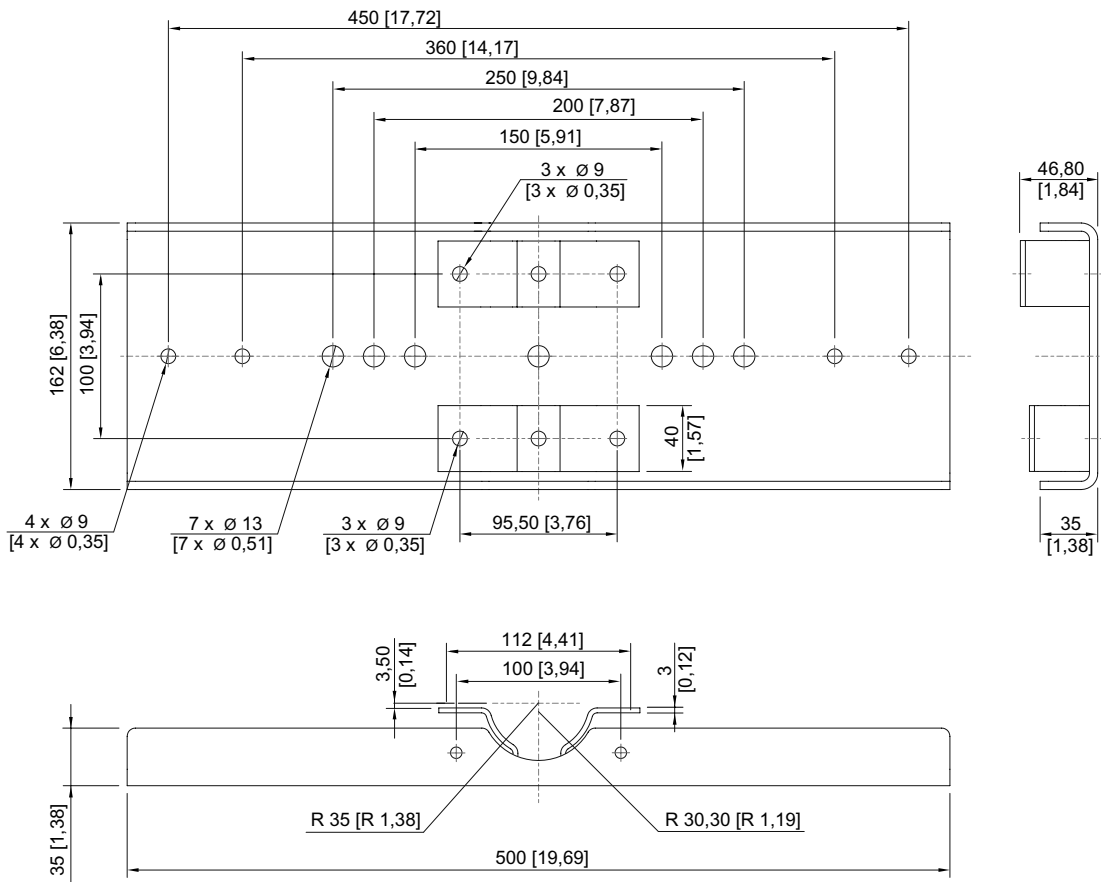

Floodlight LED

Series 6125/2

E2

