

EVL-B

- Zone 1, 2, 21, 22
- Replaces traditional discharge lamps more than 400W
- Saves in energy, maintenance and installation costs
- Suitable for GAS category IIC

'Ex op is'
safe optical radiation
WORK IN PROGRESS



EVL-...B series LED floodlights

The new LED EVL-...B series floodlights combines a light and compact design with great versatility, ease of installation and high lighting performance thanks to high intensity and efficiency LED plates which may be combined along with lens available with light beam with different shades.

The EVL-...B series consists of two sizes that can replace traditional floodlights with discharge lamps of low and medium power: EVL-60B floodlight reaches 2.270 lm while the EVL-70B one has a light output of 3.700 lm. The design of the finned body, made of aluminium alloy, acts as a heat dissipater for the LED plate, allowing a fast and effective dispersion of heat generated by the normal operation of the LEDs. Furthermore, the air particles around the floodlight do not ionize, an intrinsic characteristic of LED technology that limits the attraction of dust and insects thanks to the absence of UV emission. EVL -... B series floodlights can be powered through an electric cable and a simple 'Ex e' cable gland (no barrier). Moreover, an opposed plugged hole permits the through wiring connection. EVL-60B series floodlight can be supplied, on request, with colored LED to meet special needs such as the signalling of avoiding/ forbidden hazardous areas (red), the presence of chemicals (green) or the need to ward off wild animals and insects (yellow).

Application sectors:



DATI DI CERTIFICAZIONE

Classification:	Group II	Category 2GD		
Installation: EN 60079.14	zone 1 - zone 2 (Gas)	zone 21 - zone 22 (Dust)		
Marking:	CE 0722 Ex II 2GD Ex de IIC T.. Gb - Ex tb IIIC T..°C Db IP66			
Certification:	ATEX ITS 14 ATEX 18144			
	IEC Ex IECEX ITS 14.0061	All IEC Ex, CT RU and INMETRO certification data can be downloaded at www.cortemgroup.com		
	TR CU AVAILABLE			
	INMETRO DNV 15.0173			
Standards:	CENELEC EN 60079-0: 2012, EN 60079-1: 2009, EN 60079-7: 2007, EN60079-31: 2009 and EUROPEAN DIRECTIVE 2014/34/UE IEC 60079-0: 2011, IEC 60079-1: 2007-04, IEC 60079-31: 2013, IEC 60079-7: 2006-07			
Ambient temperature:	See "ambient temperature range" table			
Degree of protection:	IP66			



STANDARD AMBIENT TEMPERATURE RANGE FOR EVL-...B FLOODLIGHTS			
LED FLOODLIGHTS	EVL-60B		EVL-70B
AMBIENT TEMPERATURE	-20°C +40°C	-20°C +60°C	-20°C +60°C
CLASS TEMPERATURE	T6	T5	T4
MAXIMUM SURFACE TEMPERATURE	85°C	100°C	135°C

EVL-...B series LED floodlights



ORIGINAL PRODUCT

MECHANICAL FEATURES

Body:	Low copper content aluminium alloy fitted with cooling fins for better heat dissipation
Glass face:	Shock and temperature resistant tempered glass sealed with aluminium ring
Gaskets:	Acid, hydrocarbon and high temperature resistant silicone
Supporting bracket:	Stainless steel
Bolts and screws:	Stainless steel
Entries:	2 x ISO M20 entries. Fixture kit with PLG1IB plug and NAV20SIB cable gland
Coating:	Polyester coating Ral 7035 (Light grey)
Corrosion Resistance:	The STANDARD of the aluminium alloy used by Cortem has passed the tests required by standards EN60068-2-30 (hot/humid cycles) and EN60068-2-11 (salt mist tests)

EXPLODED DIAGRAM OF EVL-...B FLOODLIGHTS

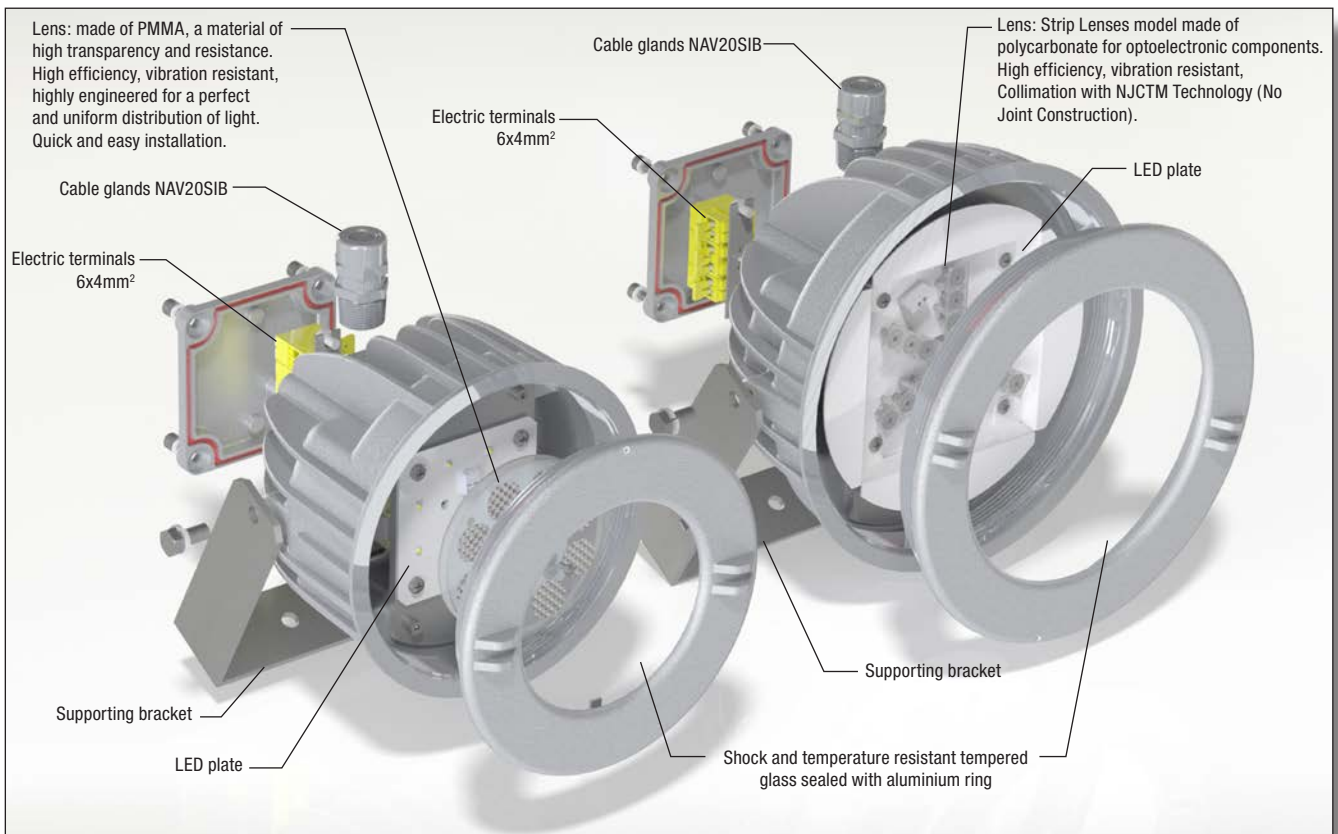

EVL-...B series LED floodlights

Electrical features	EVL-60B	EVL-70B
Power supply:	120/240/277 Vac	120/240/277 Vac
Rated frequency:	50-60 Hz ±5%	50-60 Hz ±5%
Power consumption:	33 W*	42 W*
Connection:	Direct connection to terminal board L, N, Pe. Section 4mm ² , suitable for loop-in/loop-out	
Power factor:	>0,9*	>0,94*
Rated current:	148 mA	199 mA
EMC (electromagnetic compatibility):	EN 55015, EN 61547, IEC 61000-3-2, IEC 61000-3-3, IEC 61000-4-...	
THD (total harmonic distortion):	<15% 100-240 Vac	
Over-voltage protection:	2 kV	2 kV
Driver performances:	Over-Voltage protection, Over-Current protection, Short-Circuit protection	
Dimmer (on request):	(0-10 V)	(0-10 V)
Photometric features		
LED Multichip:	Cree XTE	Cree XTE
Colour temperature:	5700 K	5700 K
CRI:	>70	>70
Instant Restrike:	YES	YES
L80:	> 60500	> 60500
Lumen:	2650 lm	3700 lm
Maximum light intensity:	1136 cd	1560 cd
Overall efficiency:	84 lm/W	88 lm/W

* Test at 230Vac

ACCESSORIES AVAILABLE / SPECIAL REQUESTS

CRI values higher
Dimmer: (code EVL-70B/**D**)
Different colour temperature (code EVL-70/**2700K**)
U bolt for pole mounting
Eyebolt

EVL-60B series floodlights can be provided with colored LEDs to meet particular requirements of signaling and lighting.

Code	Color	Possible uses
EVL-60B	White	Version for standard lighting
EVL-60B/R	Red	Red light / indication of dangerous areas
EVL-60B/V	Green	Green light/ detection of chemicals
EVL-60B/G	Amber (yellow)	Yellow light / removal of wild animals and insects
EVL-60B/BL	Blue	Blue light for specific applications

Obstruction lighting EVL-60B/G...

EVL-60B/G are the new lighting fixtures which feature a LED plate and a globe of different colours: blue, red, green, amber. They can be installed in locations where obstacles, dangers are needed to be signalled and for any visual communication. They replace acoustic signals in places where they are not applicable.

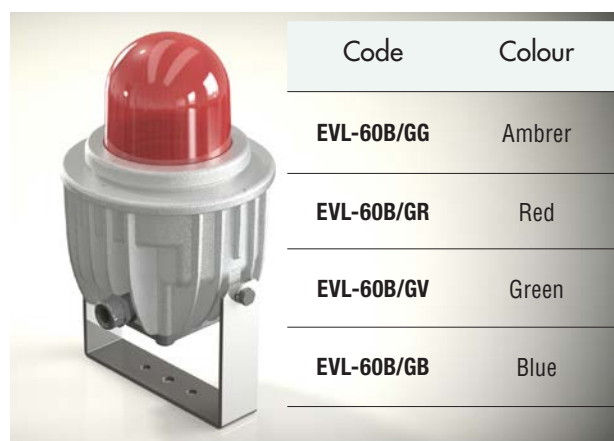

EVL ...B series selection chart, accessories and spare parts

Code	Typo Lamp	Watt*	Class	Max surface temperature °C	Weight kg	 mm
EVL-60B	LED	33 W	T5/T6	85/100	3,5	215x205x170
EVL-70B	LED	42 W	T4	135	5,2	250x235x165

* Test at 230Vac

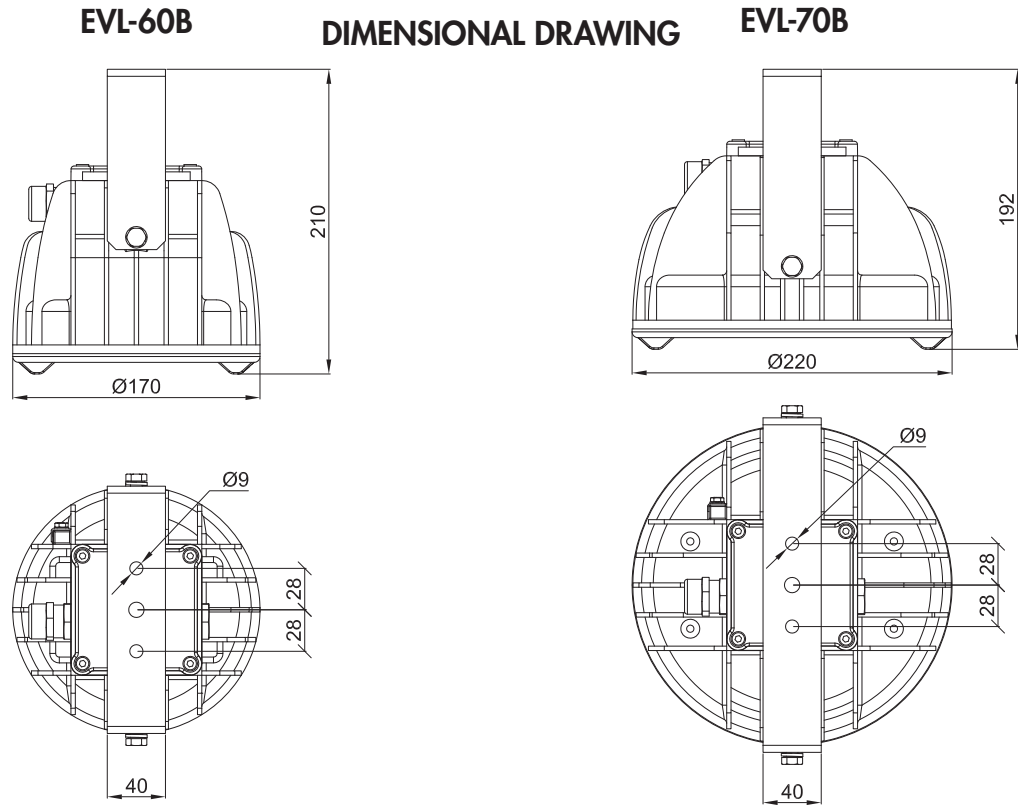













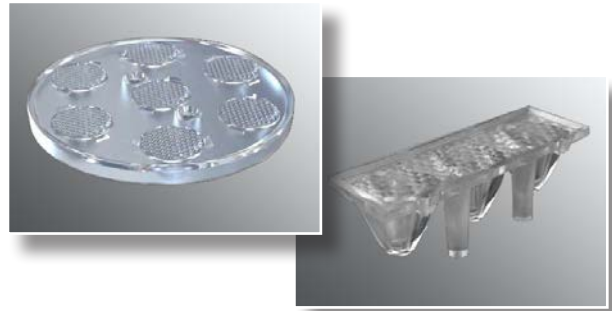

ILLUSTRATION	DESCRIPTION	MODEL	FEATURES	CODE	KEY
	Pendant eyebolt	Ø inner 20	Material: galvanised steel	G0F-8	 
	U bolt for pole mounting	for poles Ø1 1/2"	Material: stainless steel 316L	UBD5S	 
	Supporting bracket	EVL-60B	Material: stainless steel 316L	G-764	
		EVL-70B		G-765	
	Power supply	EVL-60B	120-277 Vac	LEDDEVL60B	
		EVL-70B	120-277 Vac	LEDDEVL70B	
	Cable gland	ISO M20	std. range cable 6,3÷11,6	NAV20SIB	
	Front ring with glass	EVL-60B	Aluminium ring borosilicate glass face	G60-0587	
		EVL-70B		G70-0587	

Features and photometric diagrams

Lenses available

Angle beam	EVL-60B	EVL-70B
10°	-	EVL-70B/10
20°	-	EVL-70B/20
40°	-	EVL-70B/40
60°	EVL-60B/60	-
80°	EVL-60B/80	-
120°	EVL-60B	EVL-70B



EVL-...B LED series floodlights is equipped with lenses capable to provide an adequate lighting for any application requirements of small and medium size, always taking into consideration an appropriate installation distance.

The floodlights with 120° light angle beam are supplied with no optics installed on the LED plate.

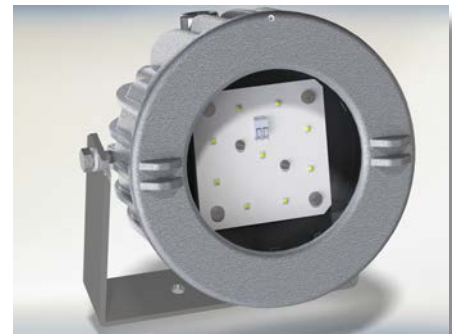
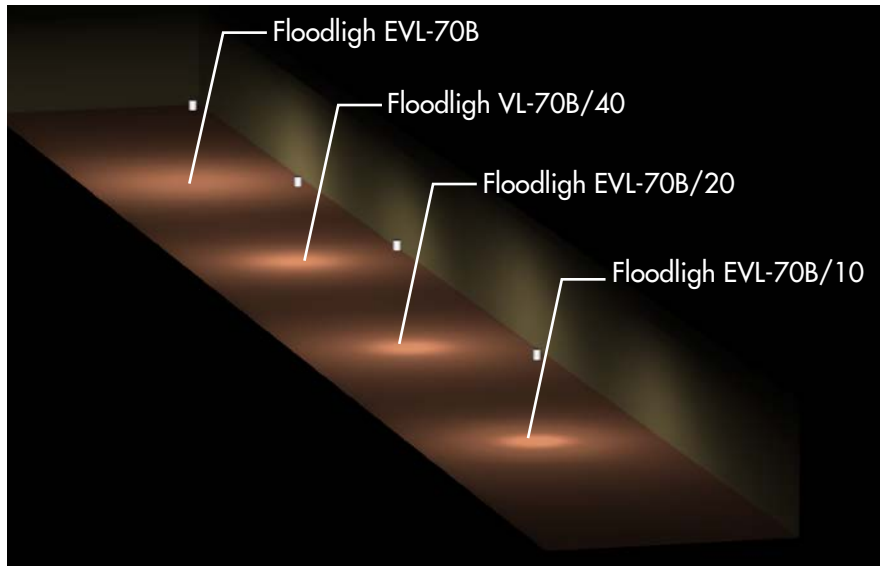

Ground lighting with different light beams available with the EVL-70B series floodlights.

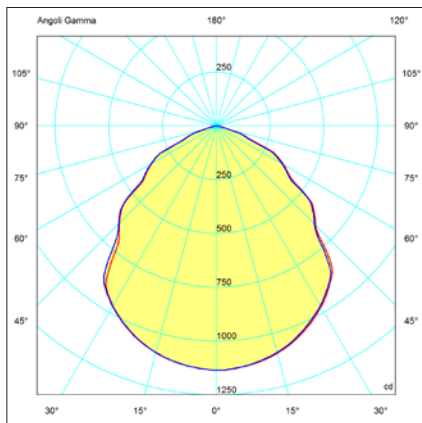

EVL-60B
Luminous flux: 2650 lm

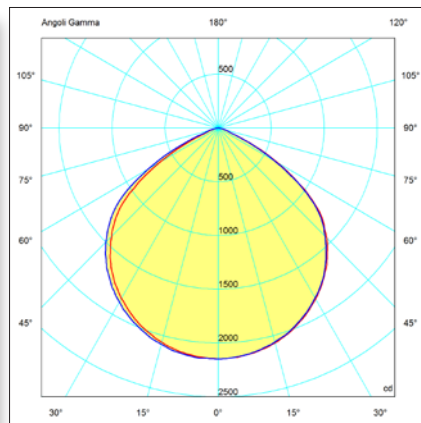

EVL-70B
Luminous flux: 3700 lm

Comparison between LED floodlights with lenses and floodlights with traditional light sources.

	EVL-60B/60	EVL-70B/40
Incandescent	300 W	500 W
Mercury vapour	250 W	400 W
Metal halide	150 W	250 W

On Cortem Group web site you can download .LDT and .IES lighting data files for the design and simulation of lighting levels in 2D and 3D, rendering and ray tracing.

— = piano 90270
— = piano 0180