

Grounding Systems / Grounding Monitoring Device

Series 8146/5075 and 8150/5-V75

www.stahl.de



14834E00

- > Monitored electrostatic earthing of tank containers, barrels, road tankers, rail cars, and IBCs during loading
- > Continuous monitoring of correct grounding
- > Robust design
- > Weather-protected plastic enclosure (IP66) or stainless steel enclosure (IP66)
- > Potential-free contact for signalling to the process control system and external control devices
- > Insulated point of suspension
- > For use up to SIL 2 (IEC 61508)



A8

The ground monitoring device ensures that tank containers, drums, road tankers, rail cars and IBCs are correctly electrostatically grounded during the loading of flammable liquids. The device provides a conductive connection to the ground and monitors in parallel the quality of the electrostatic grounding.

This guarantees that the electrostatic charge remains at a safe level and that no explosion hazard is generated by uncontrolled energy discharge.









Zone	ATEX / IECEx					
	0	1	2	20	21	22
Ex i interface	x	x	x	x	x	x
For use in		x	x		x	x

WebCode 8146H

Grounding Systems / Grounding Monitoring Device

Series 8146/5075 and 8150/5-V75

Selection Table

Version	Description	Order number	Art. no.
 <p>12753E00 Ground monitoring device 8146/5075</p>	<p>Grounding monitoring device 8146/5075 without cable. The device ensures that drums and tank containers are correctly electrostatically grounded and continuously monitors the connection.</p>	8146/5075	136216
 <p>14728E00 Ground monitoring device 8150/5-V75</p>	<p>Grounding monitoring device 8150/5-V75 without cable. The device ensures that drums and tank containers are correctly electrostatically grounded and continuously monitors the connection. For use up to SIL 2.</p>	8150/5-V75	256498
 <p>12056E00 Grounding clamp with cable</p>	<p>10 m oil and petrol resistant cable with robust ergonomic grounding clamp of stainless steel, and fast-action plug</p>		247673
 <p>12055E00 Grounding clamp with spiral cable</p>	<p>5 m oil and petrol resistant spiral cable with robust ergonomic grounding clamp of stainless steel, and fast-action plug</p>		247672
	<p>10 m oil and petrol resistant spiral cable with robust ergonomic grounding clamp of stainless steel, and fast-action plug</p>		247674
 <p>17637E00 Grounding clamp with automatic cable winder</p>	<p>Automatic winder with 9 m of oil and petrol resistant cable with robust ergonomic grounding clamp of stainless steel, and fast-action plug, Plastic enclosure</p>		247660
 <p>17636E00 Grounding clamp with automatic cable winder</p>	<p>Automatic winder with 20 m of oil and petrol resistant cable with robust ergonomic grounding clamp of stainless steel, and fast-action plug, Aluminium enclosure, protected cable duct with stopper</p>		247671
 <p>17638E00 Grounding clamp</p>	<p>Robust ergonomic grounding clamp with 150 mm of cable and fast-action plug</p>		247675
Note	*) Special cable length possible on request. Price and date of delivery differ from the standard.		

Grounding Systems / Grounding Monitoring Device

Series 8146/5075 and 8150/5-V75

Explosion Protection		
Design	8146/5075	8150/5-V75
Global (IECEX)		
Gas and dust	IECEX PTB 06.0090 Ex d e [ia Ga] IIC T4 Gb Ex tb IIIC T80°C Db	IECEX PTB 09.0049 Ex db eb [ia Ga] IIC T4 Gb Ex tb IIIC T80°C Db
Europe (ATEX)		
Gas and dust	PTB 01 ATEX 1024 ⊕ II 2 (1) G Ex d e [ia Ga] IIC T4 Gb ⊕ II 2 D Ex tb IIIC T80°C Db	PTB 09 ATEX 1109 ⊕ II 2 (1) G Ex db eb [ia Ga] IIC T4 Gb ⊕ II 2 D Ex tb IIIC T80°C Db
Certifications and certificates		
Certificates	IECEX, ATEX, Brazil (INMETRO), Kazakhstan (TR), Russia (TR), Belarus (TR)	IECEX, ATEX, Brazil (INMETRO), Kazakhstan (TR), Russia (TR), Belarus (TR)
Ship approval	DNV GL	DNV GL
Further parameters		
Installation	in Zones 1, 2, 21, 22	in Zones 1, 2, 21, 22

Technical Data

Electrical data

Power supply		
Rated voltage	110 to 230 V AC	110 to 230 V AC
Nominal voltage range	96 to 253 V AC	96 to 253 V AC
Frequency range	48 to 62 Hz	48 to 62 Hz
Nominal current	33 mA	33 mA
Power consumption	3 VA	3 VA
Cable diameter range of cable gland (M20)	6 to 13 mm	6 to 13 mm
Output		
Signalling contact	potential-free change-over contact (Ex e)	potential-free change-over contact (Ex e)
Maximum load AC	250 V / 4 A	250 V / 4 A
Maximum load DC	250 V / 2 A 40 V / 3 A	250 V / 2 A 40 V / 3 A
Max. switching capacity	50 W / 1000 VA	50 W / 1000 VA
Minimum load	12 V / 100 µA	12 V / 100 µA
LED display		

Operating mode: State of grounding

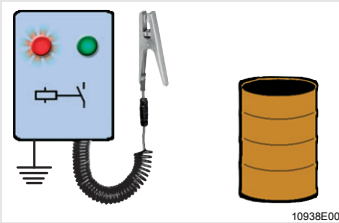

Clamp is not connected, device not in use

Reaction of the grounding monitoring device

Grounding incorrect

- red indicator lamp ON
- green indicator lamp OFF
- Switching contact OPEN

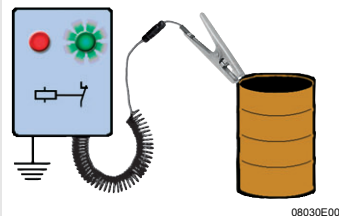

Clamp connected to tank container or drum.

Grounding ok

- red indicator lamp OFF
- green indicator lamp ON
- Switching contact CLOSED

Functional safety (IEC 61508)

Test report	Exida STAHL 11/07-089 R022		
Max. SIL	2		
Safe state	relay released / no release		
Safe Failure Fraction SFF	73%		
PFD _{AVG} at T _[Proof]	T _[Proof] 1 year	2 years	5 years
	PFD _{AVG} 4,14 x 10 ⁻⁴	7.9 x 10 ⁻⁴	1.92 x 10 ⁻³

Grounding Systems / Grounding Monitoring Device

Series 8146/5075 and 8150/5-V75

Technical Data			
Ambient conditions			
Ambient temperature	-20 to +55 °C		
Storage temperature	-40 to +80 °C		
Mechanical data			
Design	8146/5075	8150/5-V75	
Degree of protection	IP66	IP66	
Material			
Enclosure	Glass-fibre-reinforced polyester resin, flame-resistant	Stainless steel 1.4404 (AISI 316L)	
Grounding clamp	Stainless steel 1.4301 (tong limbs) and 1.4034 (clamping jaw)	Stainless steel 1.4301 (tong limbs) and 1.4034 (clamping jaw)	
Weight	5.8 kg	6.5 kg	
Mounting / Installation			
Connection		grey & green-yellow	blue
	Single-wire connection		
	- rigid	0.2 ... 6 mm ²	0.2 ... 4 mm ²
	- flexible	0.2 ... 4 mm ²	0.2 ... 2.5 mm ²
	- flex. with core end sleeves with plastic sleeve	0.25 ... 2.5 mm ²	0.25 ... 1.5 mm ²
	- flexible with core end sleeves without plastic sleeve	0.25 ... 4 mm ²	0.25 ... 2.5 mm ²
Cable gland			
Auxiliary power			
Threads	M20	M25	
Clamping range	4 to 13	7 to 17	
Auxiliary contacts			
Threads	M25	M25	
Clamping range	7 to 17 mm	7 to 17 mm	
Ex i monitoring			
Threads	M20	M20	
Clamping range	4 to 13 mm	4 to 13 mm	
Grounding clamp			
Threads	M20	M20	
Clamping range	4 to 13 mm	4 to 13 mm	
Threads	M25	M25	
Clamping range	7 to 17	7 to 17	
Tightening torque	Threads	M20	M25
	Tightening torque (at 20 °C)	1.5 Nm	2.0 Nm
Explosion Protection			
Design	Grounding clamp with cable		
Europe (ATEX)			
Gas and dust	DMT 00 ATEX E 068 X Ⓢ II 2 G Ex ia IIC T6 Gb Ⓢ II 2 D Ex ia IIIC T135°C Db		
Certifications and certificates			
Certificates	ATEX		
Europe (ATEX)			
Gas and dust	DMT 00 ATEX E 068 X Ⓢ II 2 G Ex ia IIC T6 Gb Ⓢ II 2 D Ex ia IIIC T135°C Db		
Further parameters			
Installation	in Zones 1, 2, 21, 22		
Technical Data			
Design	Grounding clamp	Cable	
Ambient conditions			
Ambient temperature	-20 to +70 °C	-20 to +90 °C	
Storage temperature	-40 to +90 °C	-40 to +90 °C	

Grounding Systems / Grounding Monitoring Device

Series 8146/5075 and 8150/5-V75

Explosion Protection		
Design	Automatic cable winder	
Europe (ATEX)		
Gas and dust	DMT 00 ATEX E 068 X Ⓜ II 2 G Ex ia IIC T6 Gb Ⓜ II 2 D Ex ia IIIC T135°C Db Maximum surface temperature: 70 °C (dependent on ambient temperature, not on device)	
Certifications and certificates		
Certificates	ATEX	
Further parameters		
Installation	in Zones 1, 2, 21, 22	
Technical Data		
Design	Automatic cable winder with 20 m of cable (art. no. 247671)	Automatic cable winder with 9 m of cable (art. no. 247660)
Ambient conditions		
Ambient temperature	-20 to +70 °C	-20 to +70 °C
Mechanical data		
Degree of protection	IP43	IP42
Material		
Enclosure	Aluminium ribbed and reinforced, protected cable duct with stopper	Plastic, cable duct with rollers
Return mechanism	automatic, stopping device can be switched on and off	--
Grounding cable	20 m oil and petrol resistant grounding cable, 3 x 1.5 mm Temperature range: -20 ... +90 °C Connected 4-pole plug receptacle, IP67	9 m oil and petrol resistant grounding cable, 3 x 1.5 mm Temperature range: -20 ... +90 °C Connected 4-pole plug receptacle, IP67
Weight	approx. 14 kg with 20 m grounding cable	approx 7.0 kg with 9 m grounding cable
Fire resistance (UL 94)	--	HB
Mounting / Installation		
Mounting	Wall mounting with mounting plate	Wall mounting with mounting plate
Connection	2.5 m, connection cable 3 x 1.5 mm ²	2.5 m, connection cable 3 x 1.5 mm ²

A8

Grounding Systems / Grounding Monitoring Device

Series 8146/5075 and 8150/5-V75

Dimensional Drawings (All Dimensions in mm [inches]) – Subject to Alterations

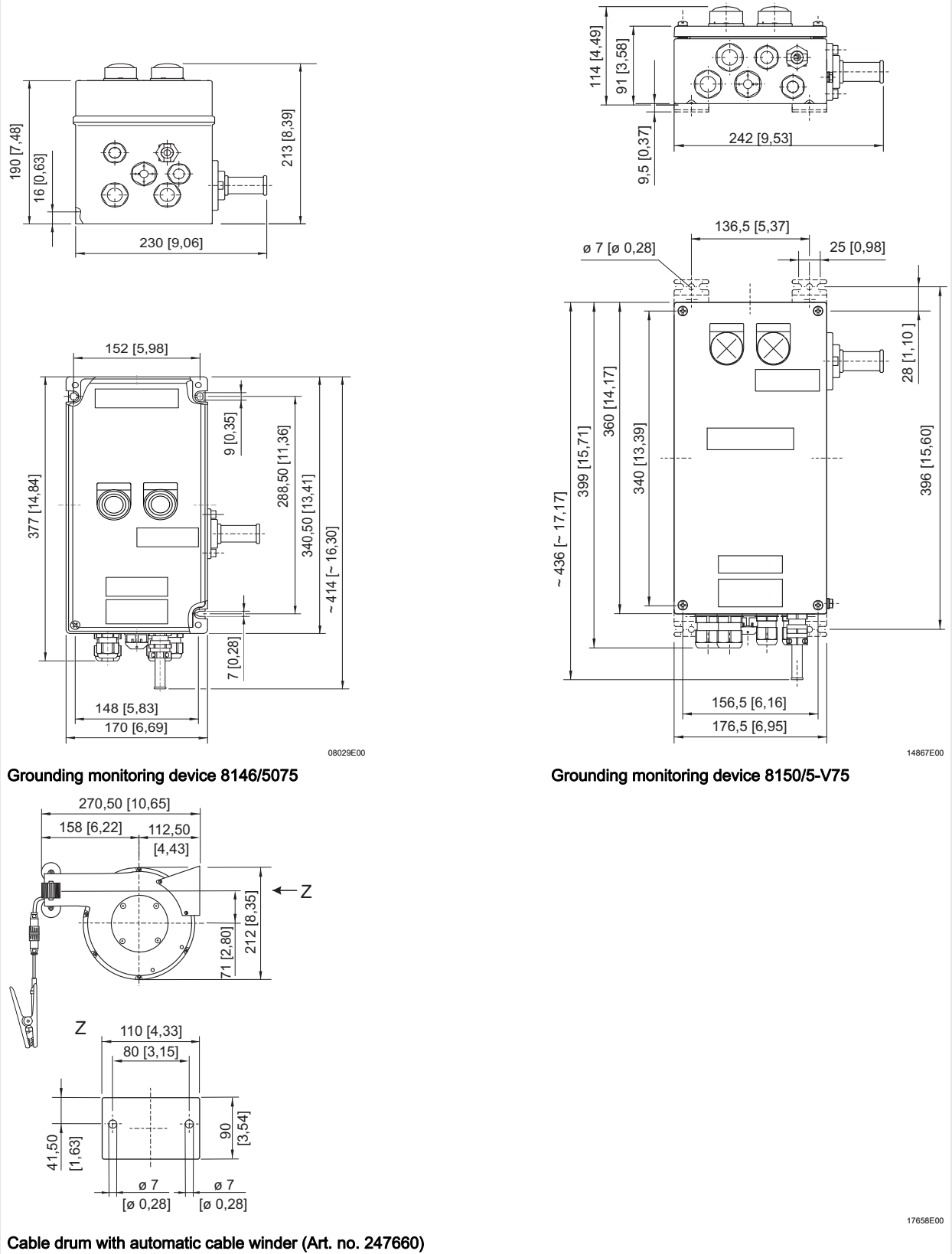

Grounding Systems / Grounding Monitoring Device

Series 8146/5075 and 8150/5-V75

Dimensional Drawings (All Dimensions in mm [inches]) – Subject to Alterations

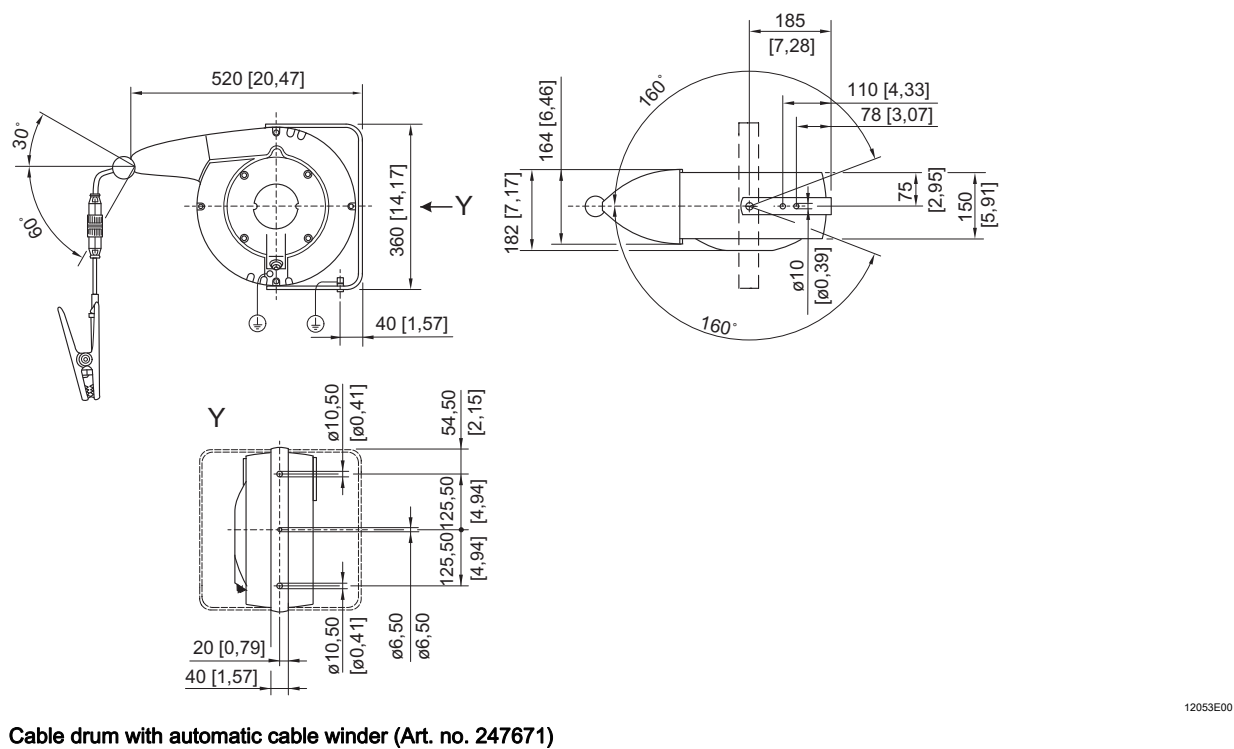

We reserve the right to make alterations to the technical data, dimensions, weights, designs and products available without notice. The illustrations cannot be considered binding.