

Visual Signalling Device

Series FX15 - Ex d, XENON / LED, GRP

E5



- Lamp: Flashing beacon – XENON (5 J) / continuous beacon – LED (6.5 W)
- Type of protection: Ex d
- Class: IP66/IP67 (IEC 60529 / NEMA 4X)
- Corrosion-resistant GRP enclosure
- Stainless steel protection cage included
- 8 light-intensifying Fresnel lens colours available to order
- Low weight (2.25 kg)

WebCode **FX15A**



Product series FX15 provides visual signals from a continuous beacon with an LED or a 5 J lashing beacon with xenon flashes. The enclosure is made of glass fibre reinforced polyester. The product series is intended for use in hazardous areas and harsh environments.

	IECEX / ATEX					
Zone	0	1	2	20	21	22
Installation in		•	•		•	•

Selection Table				
Lamp	LED			
Rated operational voltage AC	100 – 254 V			
Lens colour	Product Type		Art. No.	Weight kg
Amber	FX15/C-P-060-A-EN-SF-A-ST-00-00-00		247077	2.250
Blue	FX15/C-P-060-B-EN-SF-A-ST-00-00-00		247069	2.250
Clear	FX15/C-P-060-C-EN-SF-A-ST-00-00-00		247085	2.250
Green	FX15/C-P-060-G-EN-SF-A-ST-00-00-00		247061	2.250
Red	FX15/C-P-060-R-EN-SF-A-ST-00-00-00		247093	2.250
Lamp	LED			
Rated operational voltage DC	24 V			
Lens colour	Product Type		Art. No.	Weight kg
Blue	FX15/C-D-060-B-EN-SF-A-ST-00-00-00		247070	2.230
Clear	FX15/C-D-060-C-EN-SF-A-ST-00-00-00		247086	2.230
Green	FX15/C-D-060-G-EN-SF-A-ST-00-00-00		247062	2.230
Magenta	FX15/C-D-060-M-EN-SF-A-ST-00-00-00		251767	2.230
Lamp	LED			
Lens colour	Product Type		Art. No.	Weight kg
Amber	FX15/C-D-060-A-EN-SF-A-ST-00-00-00		247078	2.230
Red	FX15/C-D-060-R-EN-SF-A-ST-00-00-00		247094	2.230

Visual Signalling Device

Series FX15 - Ex d, XENON / LED, GRP

E5

Selection Table				
Lamp	Xenon flash tubes			
Rated operational voltage AC	115 V			
Lens colour	Product Type	Art. No.	Weight kg	
Amber	FX15/C-L-050-A-EN-SF-A-ST-00-00-00	217981	2.250	
Clear	FX15/C-L-050-C-EN-SF-A-ST-00-00-00	217983	2.250	
Green	FX15/C-L-050-G-EN-SF-A-ST-00-00-00	217993	2.250	
Red	FX15/C-L-050-R-EN-SF-A-ST-00-00-00	217973	2.250	
Lamp	Xenon flash tubes			
Rated operational voltage AC	230 V			
Lens colour	Product Type	Art. No.	Weight kg	
Amber	FX15/C-N-050-A-EN-SF-A-ST-00-00-00	217982	2.250	
	FX15/C-N-050-A-RU-SF-A-ST-00-00-00	250498	2.250	
Blue	FX15/C-N-050-B-EN-SF-A-ST-00-00-00	218002	2.250	
Clear	FX15/C-N-050-C-EN-SF-A-ST-00-00-00	217995	2.250	
Green	FX15/C-N-050-G-EN-SF-A-ST-00-00-00	218003	2.250	
	FX15/C-N-050-G-RU-SF-A-ST-00-00-00	257179	2.250	
Red	FX15/C-N-050-R-EN-SF-A-ST-00-00-00	217974	2.250	
	FX15/C-N-050-R-RU-SF-A-ST-00-00-00	238878	2.250	
Yellow	FX15/C-N-050-Y-EN-SF-A-ST-00-00-00	218001	2.250	
	FX15/C-N-050-Y-RU-SF-A-ST-00-00-00	250499	2.250	
Lamp	Xenon flash tubes			
Rated operational voltage DC	24 V			
Lens colour	Product Type	Art. No.	Weight kg	
Amber	FX15/C-D-050-A-RU-SF-A-ST-00-00-00	239122	2.230	
Blue	FX15/C-D-050-B-EN-SF-A-ST-00-00-00	217992	2.230	
Clear	FX15/C-D-050-C-EN-SF-A-ST-00-00-00	217989	2.230	
Red	FX15/C-D-050-R-RU-SF-A-ST-00-00-00	239121	2.230	
Yellow	FX15/C-D-050-Y-RU-SF-A-ST-00-00-00	252025	2.230	
Lamp	Xenon flash tubes			
Rated operational voltage DC	24 V			
Lens colour	Product Type	Art. No.	Weight kg	
Amber	FX15/C-D-050-A-EN-SF-A-ST-00-00-00	217979	2.230	
Green	FX15/C-D-050-G-EN-SF-A-ST-00-00-00	217997	2.230	
Red	FX15/C-D-050-R-EN-SF-A-ST-00-00-00	217971	2.230	
Yellow	FX15/C-D-050-Y-EN-SF-A-ST-00-00-00	217991	2.230	

Technical Data		
Variant	FX15/-P-060- LED	FX15/-N-050- Xenon flash tubes
Explosion Protection		
IECEx gas explosion protection	Ex d IIC T6 Gb	Ex d IIC T6 ... T4 Gb
IECEx dust explosion protection	Ex tb IIIC T85 °C Db	Ex tb IIIC T75 °C ... T105 °C Db
ATEX gas explosion protection	Ⓔ II 2 G Ex d IIC T6 Gb	Ⓔ II 2 G Ex d IIC T6 ... T4 Gb
ATEX dust explosion protection	Ⓔ II 2 D Ex tb IIIC T85 °C Db	Ⓔ II 2 D Ex tb IIIC T75 °C ... T105 °C Db
Certificates	ATEX (BAS), IECEx (BAS)	ATEX (BAS), IECEx (BAS)

Visual Signalling Device

Series FX15 - Ex d, XENON / LED, GRP

E5

Technical Data		
Variant	FX15/-P-060-LED	FX15/-N-050-Xenon flash tubes
Electrical Data		
Tolerance	-10 – 10 %	-10 – 10 %
Ambient Conditions		
Operating temperature	-60 °C ... +50 °C	-55 °C ... +70 °C
Mechanical Data		
IP degree of protection (IEC 60529)	IP66/IP67	IP66/IP67
Enclosure material	Polyester (GRP), Glass fibre reinforced	Polyester (GRP), Glass fibre reinforced
Enclosure colour	Black	Black
Seal	O-ring seal	O-ring seal
Sealing material	Red silicone 70	Red silicone 70
Material dome	Polycarbonate, prismatic	Polycarbonate, prismatic
Wire guard material	Stainless steel	Stainless steel
Max. solid connection terminals	2.5 mm ²	2.5 mm ²
Max. finely stranded connection terminals	2.5 mm ²	2.5 mm ²
Mounting / Installation		
Mounting part material	Stainless steel	Stainless steel
Connection type	Screw terminal	Screw terminal
Components		
Drilled holes	3 x M20	3 x M20
Cable glands and entries	Can be ordered as accessories	Can be ordered as accessories
Stopping plugs	3 x dust cap	3 x dust cap
You can find more technical data online at r-stahl.com . WebCode FX15A		

Technical Drawings – Subject to Alterations

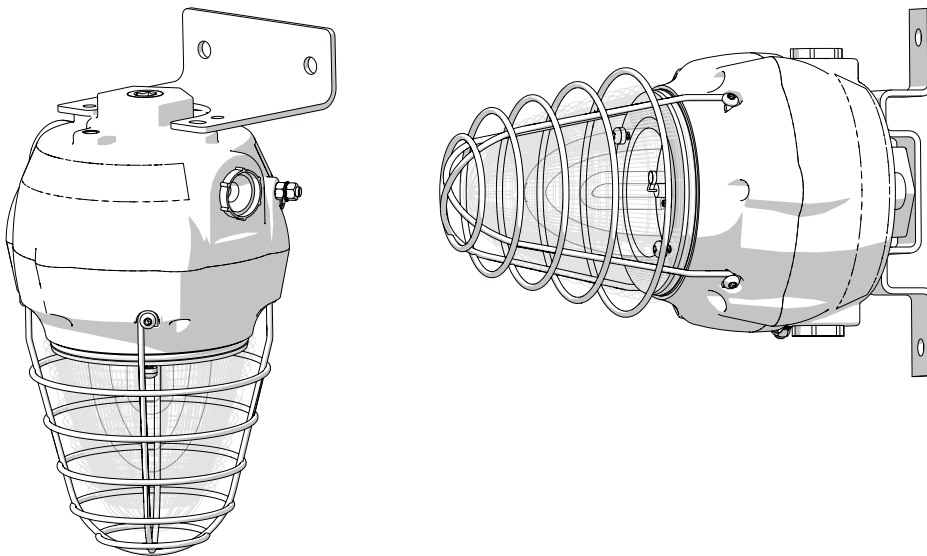







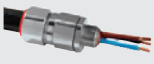

Visual Signalling Device

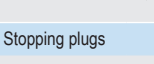
Series FX15 - Ex d, XENON / LED, GRP

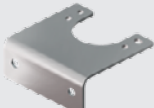
E5





Accessories

Figure	Description	Art. No.	Weight kg
Cable glands made of metal			
	Ex d & Ex e cable gland for all types of unarmoured and braid armour cables (nickel plated brass) Type 20A2F, M20 x 1.5	243464 ▲	0.070
	Ex d & Ex e cable entry with compound for all types of armoured cables (SWA, braided, tape) (nickel-plated brass) Type 20PX2K, M20 x 1.5	109428 ▲	0.240
	Ex d & Ex e Cable entry with RapidEx sealing system for all types of unarmoured and braid armour cables (nickel-plated brass) Type 20PX2K-REX, M20 x 1.5	246649 ■	0.240
	Ex d & Ex e Cable entry with compound gland for all types of unarmoured and braid armour cables (nickel plated brass) Type 20PXSS2K, M20 x 1.5	109441 ▲	0.200
	Ex d & Ex e Cable entry with RapidEx sealing system for all types of unarmoured and braid armour cables (nickel-plated brass) Type 20PXSS2K-REX, M20 x 1.5	246605 ■	0.200
	Ex d & Ex e cable gland for all types of armoured cables (SWA, braided, tape) (nickel plated brass) with unique compensating displacement seal system (CDS) Type 20T3CDS, M20 x 1.5	246561 ▲	0.280
Stopping plugs			
	Stopping plug made of stainless steel M20x1,5 with external hexagon	251101 ▲	0.079
Mounting accessories			
	Stainless steel L-bracket; standard — see dimensional drawings	221711	0.287
	Adapter plate for pipe clamp fastening (available for FL6S, FX15, YL6S)	256519	0.630
	Sun shield, stainless steel (available for FX15)	262077	0.200
	Pipe clamp, R 1 1/2"	120819	0.470
	Pipe clamp, R 1 1/4"	120812	0.500
	Pipe clamp, R 2"	120823	0.500
	Fastening bracket, stainless steel (available for FX15)	221712	0.155

Visual Signalling Device

Series FX15 - Ex d, XENON / LED, GRP

E5

Spare Parts			
Figure	Description	Art. No.	Weight kg
Flange			
	Flange, ATEX, amber (available for FL6S, FX15, YL6S)	243407	1.190
	Flange, ATEX, blue (available for FL6S, FX15, YL6S)	243406	1.190
	Flange, ATEX, clear (available for FL6S, FX15, YL6S)	223578	1.190
	Flange, ATEX, green (available for FL6S, FX15, YL6S)	243405	1.190
	Flange, ATEX, red (available for FL6S, FX15, YL6S)	243408	1.190
	Flange, ATEX, yellow (available for FL6S, FX15, YL6S)	243409	1.190
Fresnel lens			
	Fresnel lens blue replacement	292141	0.180
	Fresnel lens red replacement	292147	0.180
Lamp			
	Xenon lamp (available for FL6S, FX15, YL6S)	223636	0.006
PCB			
	Connection PCB (available for FL6S, FX15, YL6S)	223579	0.020
	Electronic PCB, 115 V AC, 5 J (available for FL6S, FX15, YL6S)	223632	0.118
	Electronic PCB, 230 V AC, 5 J (available for FL6S, FX15, YL6S)	223580	0.100
	Electronic PCB, 24 V DC, 5 J (available for FL6S, FX15, YL6S)	223635	0.080

FX15 Beacons are supplied without a bracket. These must be ordered separately (see accessories table).

Visual Signalling Device

Series FX15 - Ex d, XENON / LED, GRP

E5

Dimensional Drawings (All Dimensions in mm [inches]) – Subject to Alterations

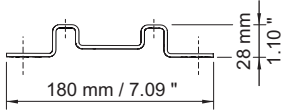
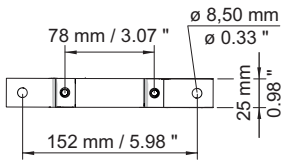

Backstrap bracket

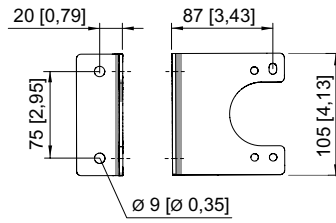

L-shaped bracket

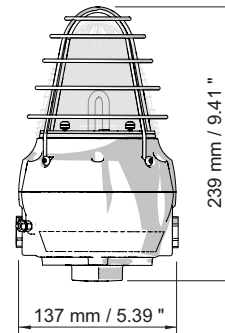
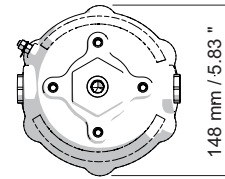

FX15 Beacon

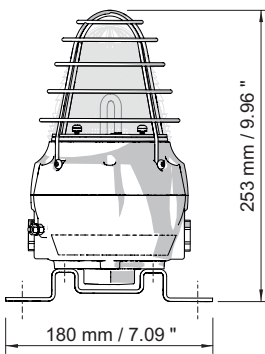
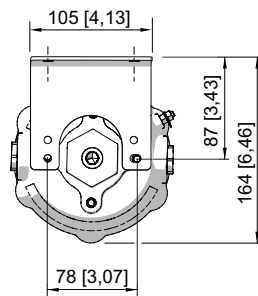
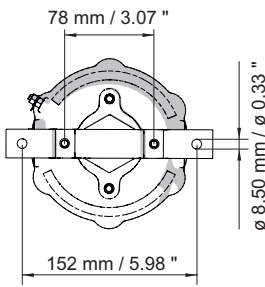

FX15 Beacon with backstrap bracket

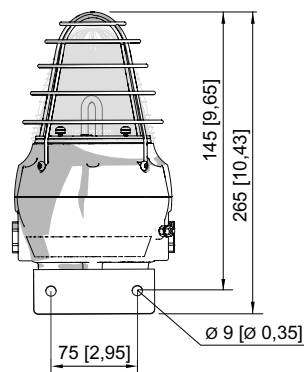

FX15 Beacon with L-bracket